

DATA SHEET

BF851A; BF851B; BF851C N-channel junction FETs

Product specification
File under Discrete Semiconductors, SC07

1995 Apr 14

Philips Semiconductors



PHILIPS

N-channel junction FETs

BF851A; BF851B; BF851C

FEATURES

- High transfer admittance
- Low input capacitance
- Low feedback capacitance
- Low noise.

APPLICATIONS

- Preamplifiers for AM tuners in car radios.

DESCRIPTION

N-channel symmetrical junction field effect transistors in a SOT54 (TO-92) package.

PINNING - SOT54 (TO-92)

PIN	SYMBOL	DESCRIPTION
1	g	gate
2	s	source
3	d	drain

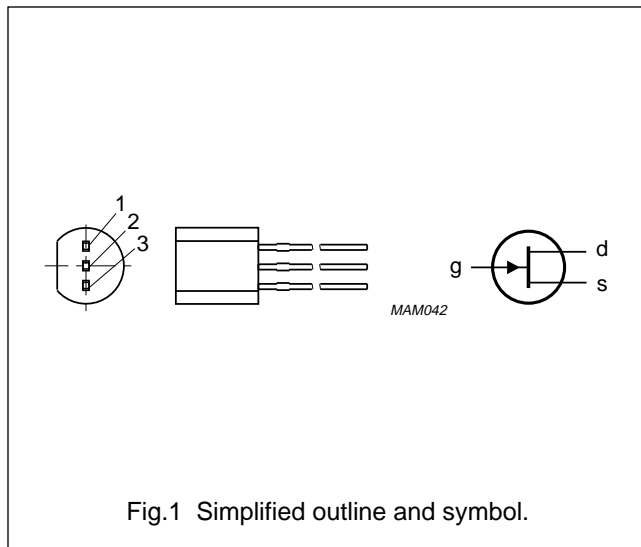

Fig.1 Simplified outline and symbol.

CAUTION

The device is supplied in an antistatic package. The gate-source input must be protected against static discharge during transport or handling.

QUICK REFERENCE DATA

SYMBOL	PARAMETER	CONDITIONS	MIN.	MAX.	UNIT
V_{DS}	drain-source voltage (DC)		–	25	V
I_{DSS}	drain current	$V_{GS} = 0; V_{DS} = 8\text{ V}$			
	BF851A		2	6.5	mA
	BF851B		6	15	mA
	BF851C		12	25	mA
P_{tot}	total power dissipation	up to $T_{amb} = 40\text{ °C}$	–	400	mW
$ y_{fs} $	forward transfer admittance	$V_{GS} = 0; V_{DS} = 8\text{ V}$			
	BF851A		12	20	mS
	BF851B		16	25	mS
	BF851C		20	30	mS
C_{iss}	input capacitance	$f = 1\text{ MHz}$	–	10	pF
C_{rss}	reverse transfer capacitance	$f = 1\text{ MHz}$	–	3	pF

N-channel junction FETs

BF851A; BF851B; BF851C

LIMITING VALUES

In accordance with the Absolute Maximum Rating System (IEC 134).

SYMBOL	PARAMETER	CONDITIONS	MIN.	MAX.	UNIT
V_{DS}	drain-source voltage (DC)		–	25	V
V_{GSO}	gate-source voltage	open drain	–	25	V
V_{DGO}	drain-gate voltage (DC)	open source	–	25	V
I_G	forward gate current (DC)		–	10	mA
P_{tot}	total power dissipation	up to $T_{amb} = 40\text{ °C}$; note 1	–	400	mW
T_{stg}	storage temperature		–65	+150	°C
T_j	operating junction temperature		–	150	°C

Note

1. Device mounted on an epoxy printed-circuit board; maximum lead length 4 mm; mounting pad for the drain lead minimum 10 mm².

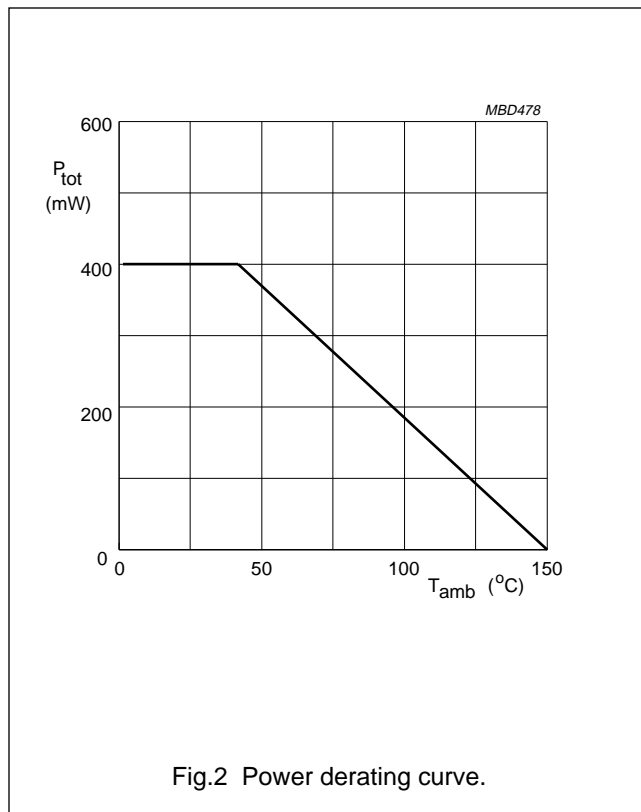

N-channel junction FETs

BF851A; BF851B; BF851C

THERMAL CHARACTERISTICS

SYMBOL	PARAMETER	VALUE	UNIT
$R_{th\ j-a}$	thermal resistance from junction to ambient; note 1	250	K/W

Note

1. Device mounted on an epoxy printed-circuit board; maximum lead length 4 mm; mounting pad for the drain lead minimum 10 mm².

CHARACTERISTICS

$T_j = 25\text{ °C}$; $V_{DS} = 8\text{ V}$; $V_{GS} = 0$; unless otherwise specified.

SYMBOL	PARAMETER	CONDITIONS	MIN.	TYP.	MAX.	UNIT
$V_{(BR)GSS}$	gate-source breakdown voltage	$I_G = -1\ \mu\text{A}$	-25	–	–	V
V_{GSoff}	gate-source cut-off voltage	$I_D = 1\ \mu\text{A}$				
	BF851A		-0.2	–	-1	V
	BF851B		-0.5	–	-1.5	V
	BF851C		-0.8	–	-2	V
V_{GSS}	gate-source forward voltage	$V_{DS} = 0$; $I_G = 1\ \text{mA}$	–	–	1	V
I_{DSS}	drain current					
	BF851A		2	–	6.5	mA
	BF851B		6	–	15	mA
	BF851C		12	–	25	mA
I_{GSS}	gate cut-off current	$V_{GS} = -20\ \text{V}$; $V_{DS} = 0$	–	–	-1	nA
$ y_{fs} $	forward transfer admittance					
	BF851A		12	–	20	mS
	BF851B		16	–	25	mS
	BF851C		20	–	30	mS
g_{os}	common source output conductance					
	BF851A		–	–	200	μS
	BF851B		–	–	250	μS
	BF851C		–	–	300	μS
C_{iss}	input capacitance	$f = 1\ \text{MHz}$	–	–	10	pF
C_{rss}	reverse transfer capacitance	$f = 1\ \text{MHz}$	–	2.4	3	pF
V_n/\sqrt{B}	equivalent input noise voltage	$V_{GS} = 0$; $f = 1\ \text{MHz}$	–	1.5	–	nV/ $\sqrt{\text{Hz}}$

N-channel junction FETs

BF851A; BF851B; BF851C

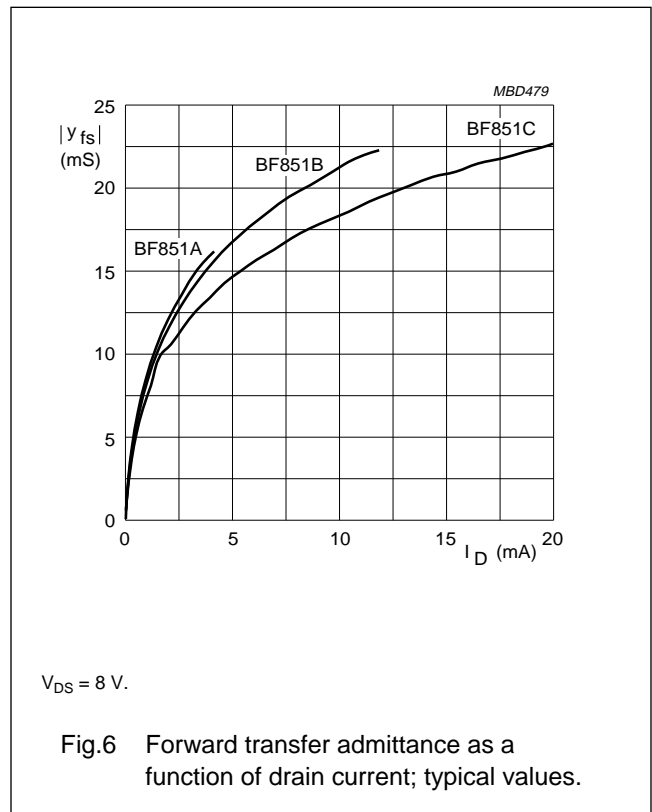
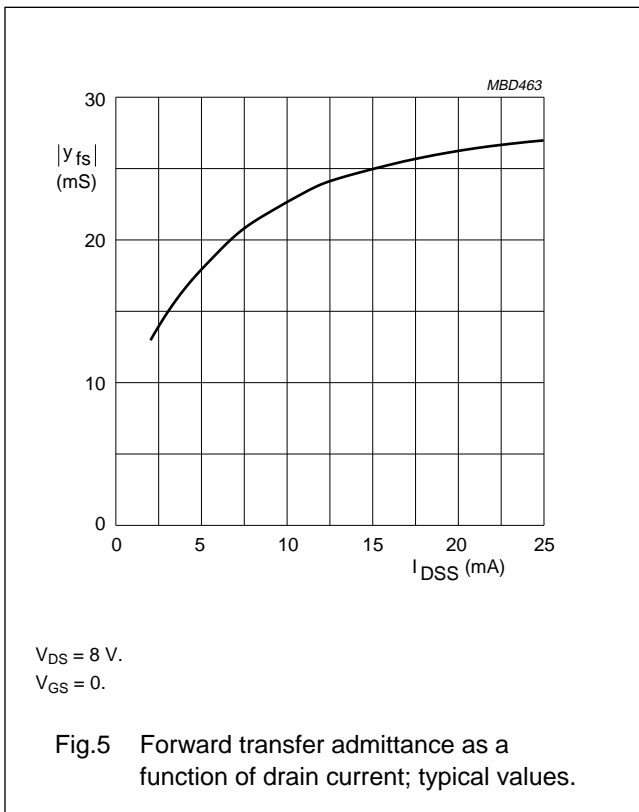
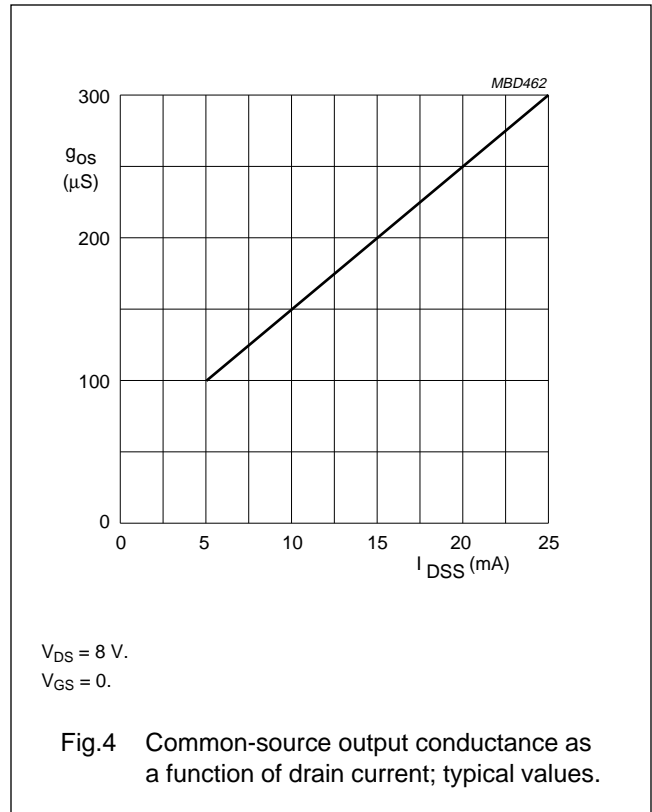
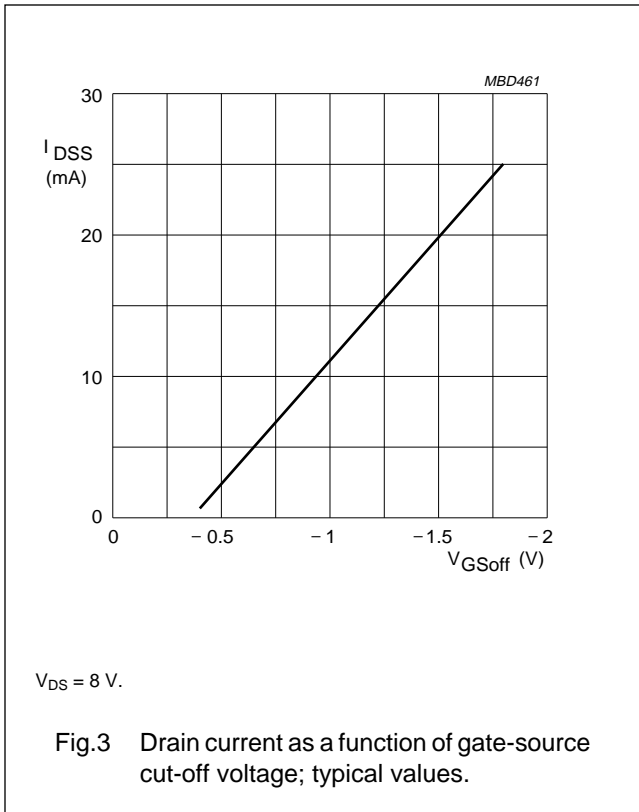

N-channel junction FETs

BF851A; BF851B; BF851C

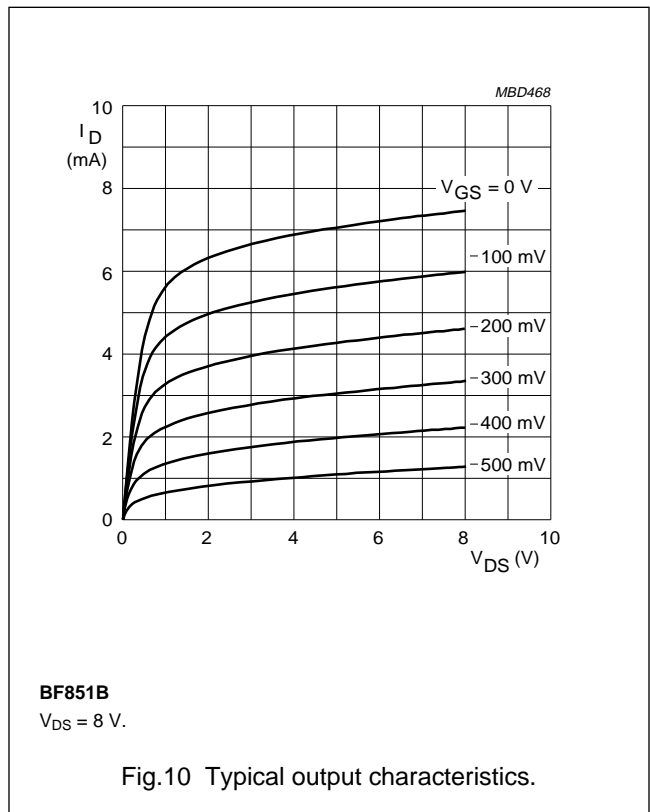
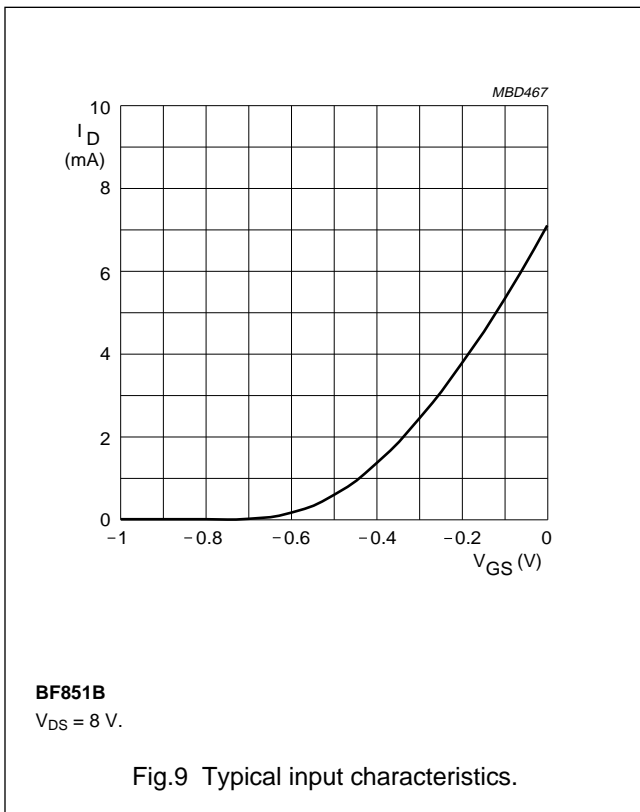
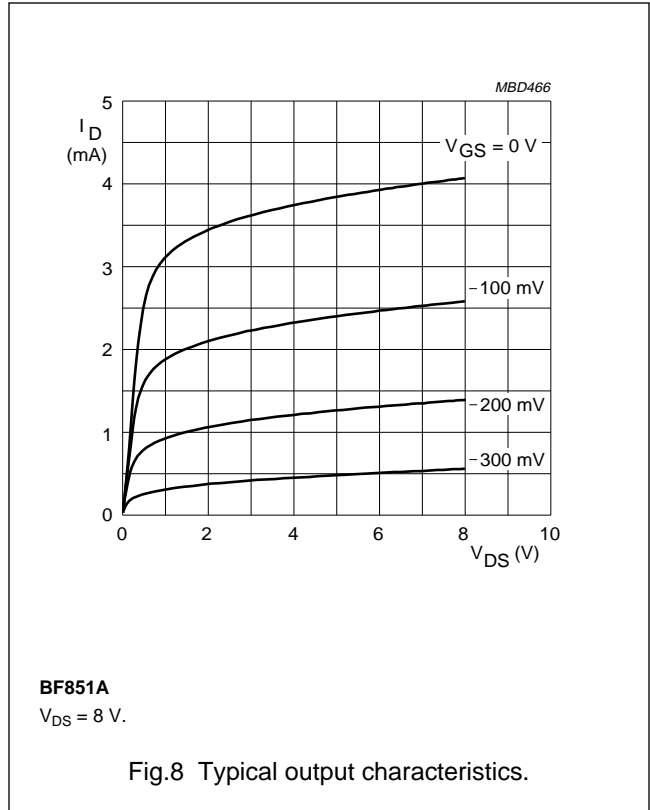
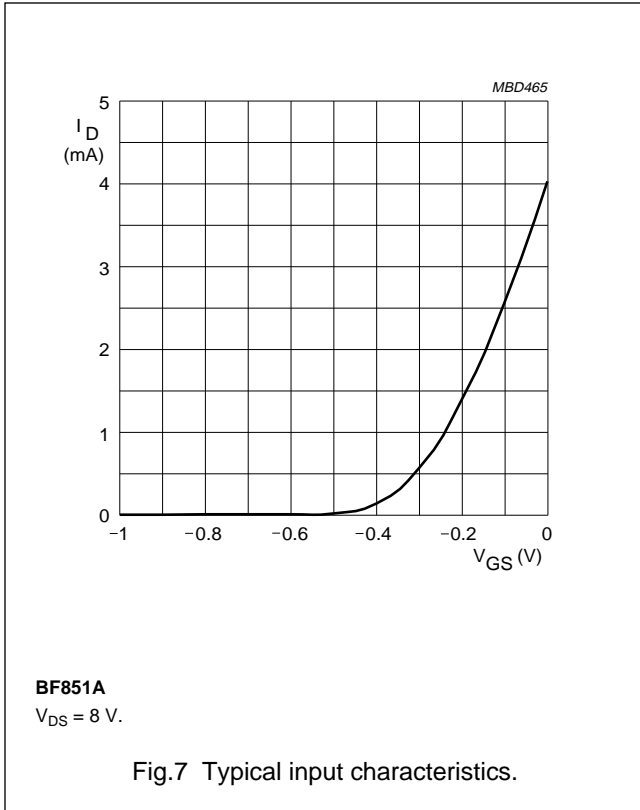

N-channel junction FETs

BF851A; BF851B; BF851C

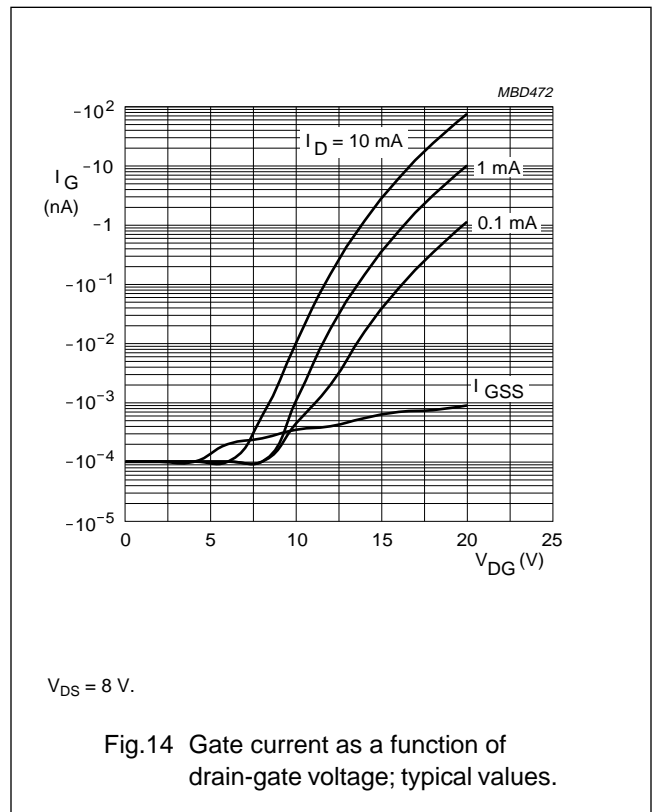
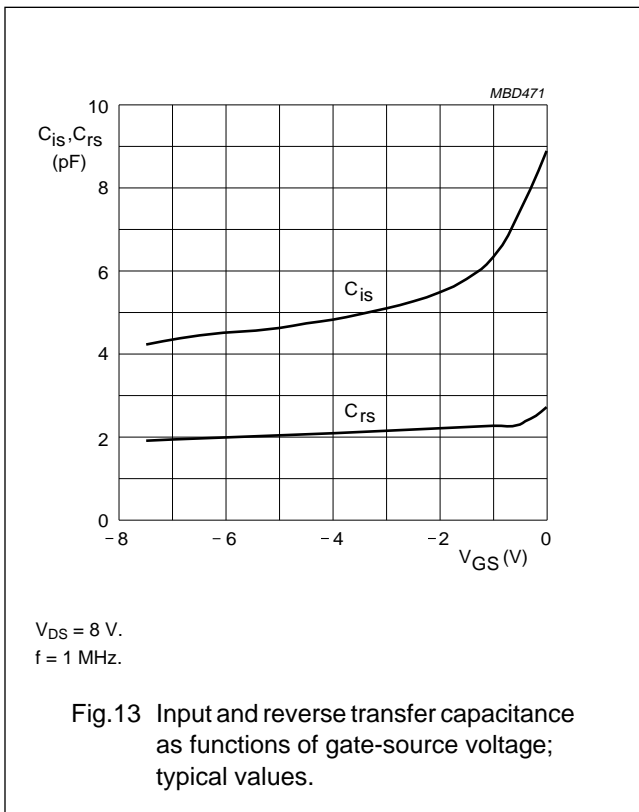
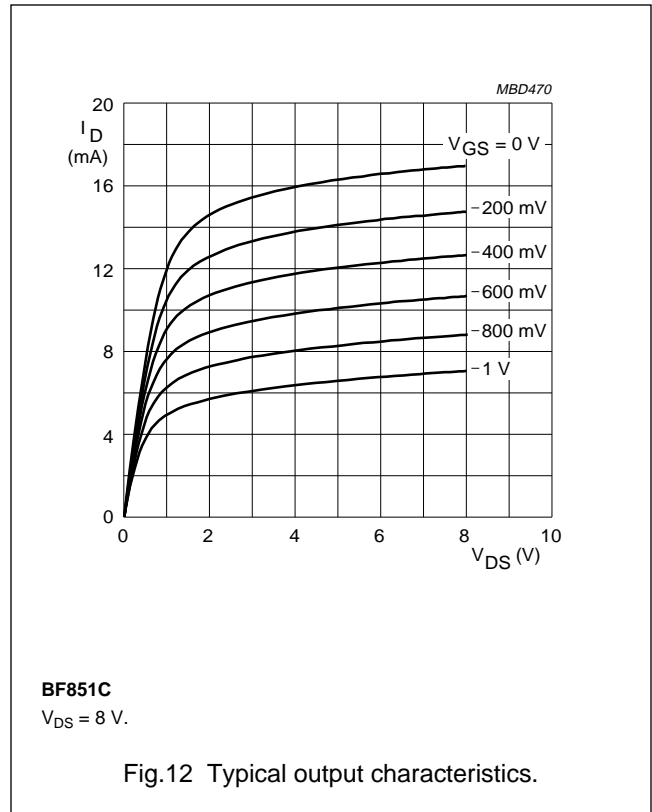
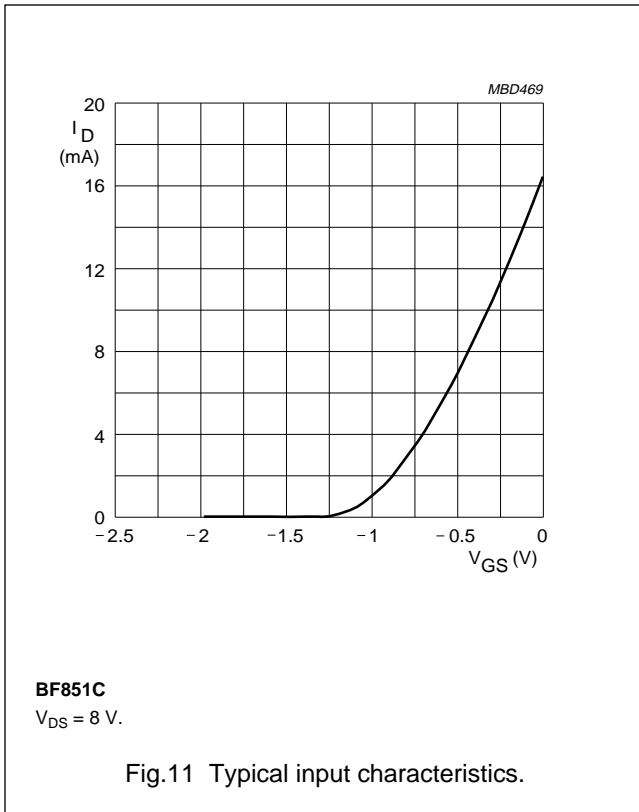

N-channel junction FETs

BF851A; BF851B; BF851C

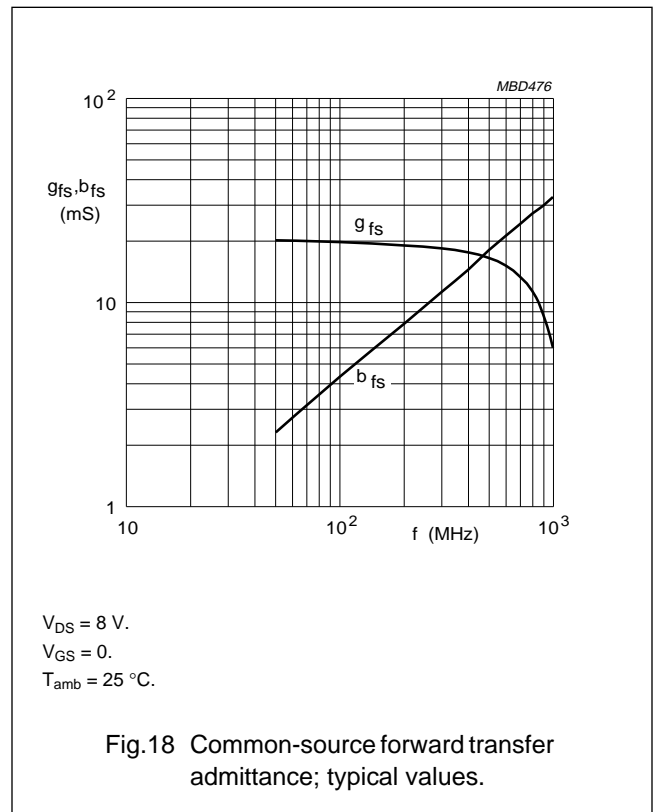
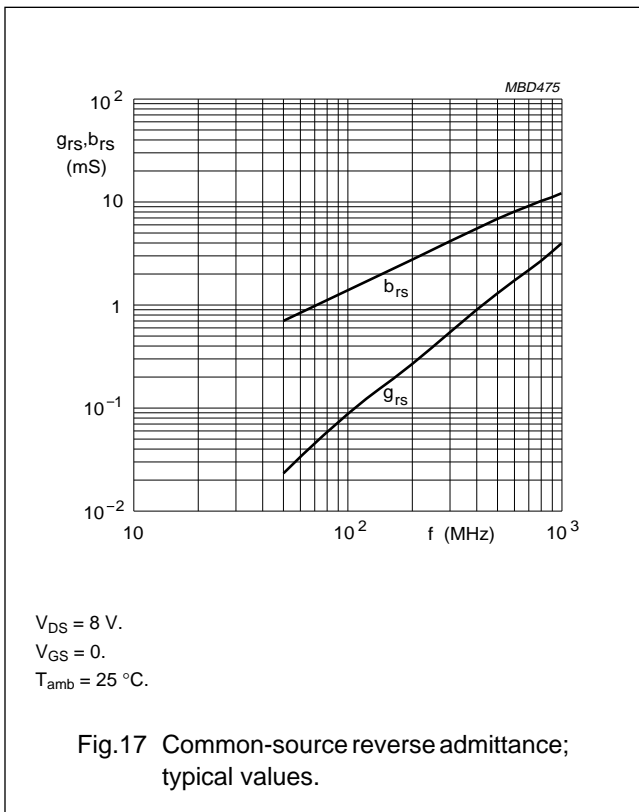
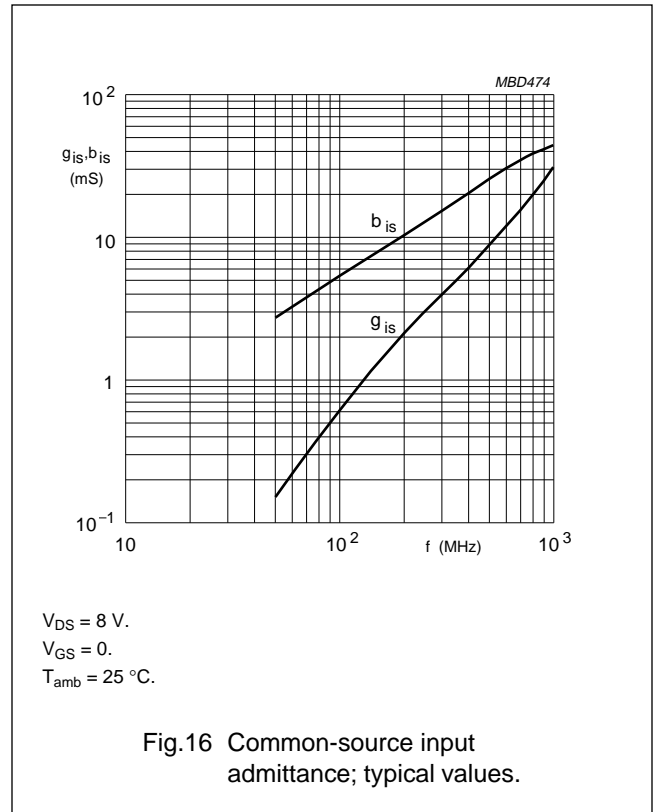
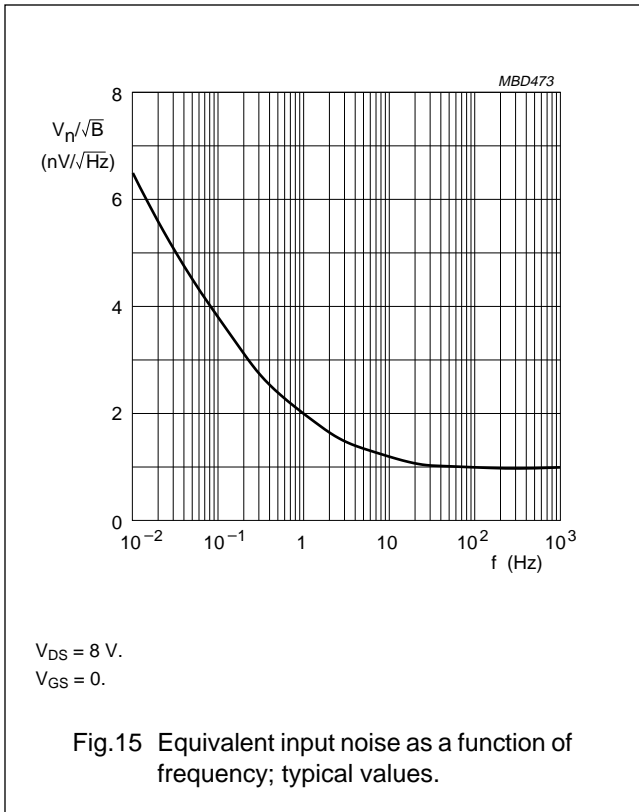

N-channel junction FETs

BF851A; BF851B; BF851C

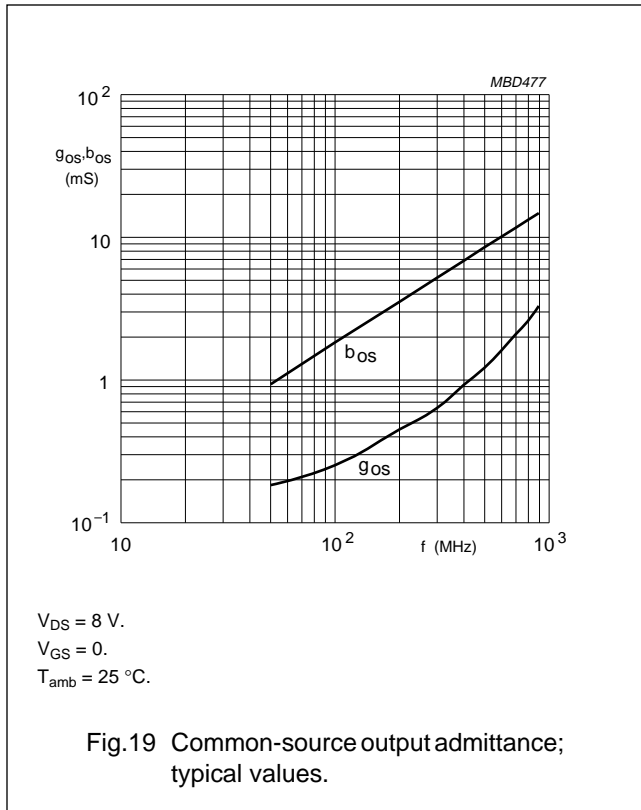

N-channel junction FETs

BF851A; BF851B; BF851C

PACKAGE OUTLINE

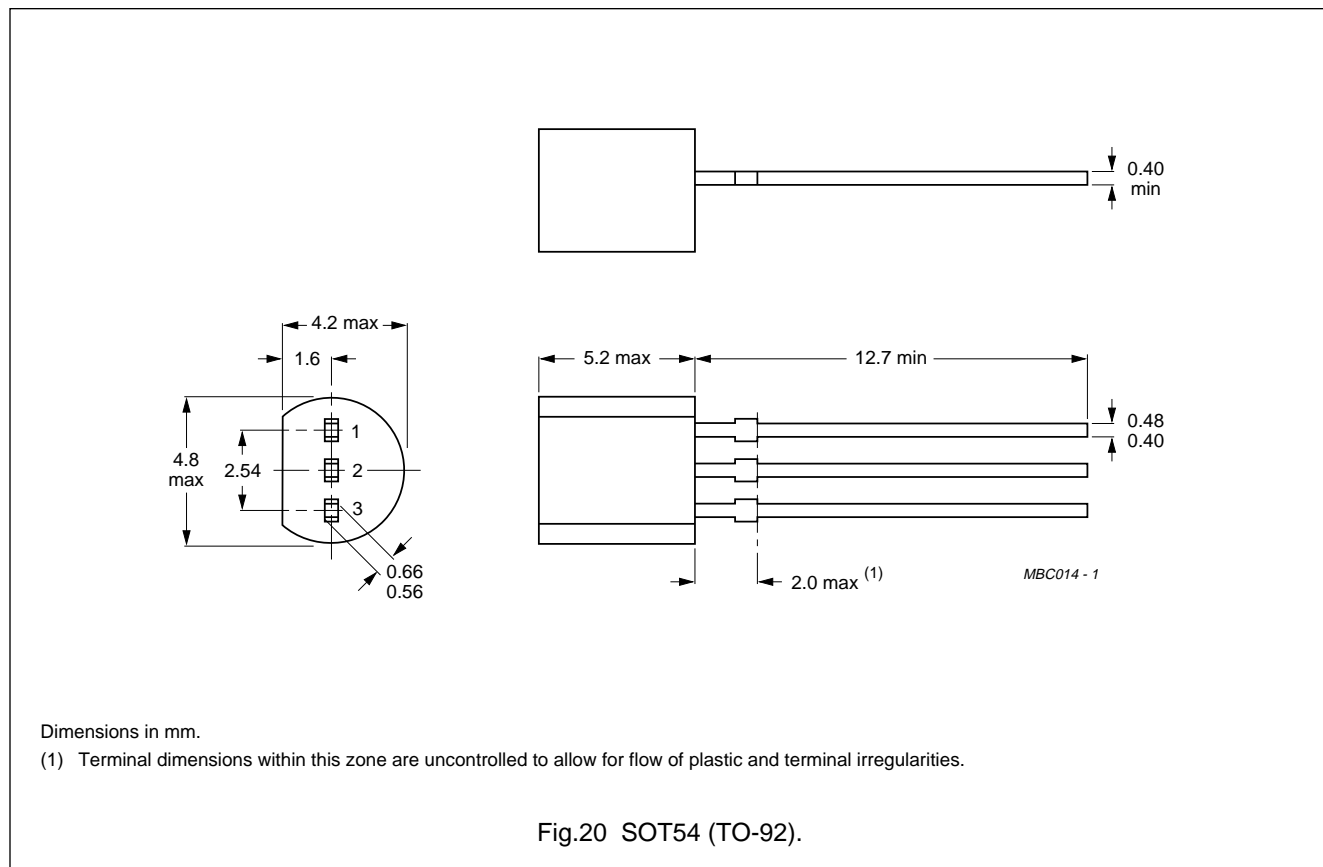

N-channel junction FETs

BF851A; BF851B; BF851C

DEFINITIONS

Data Sheet Status	
Objective specification	This data sheet contains target or goal specifications for product development.
Preliminary specification	This data sheet contains preliminary data; supplementary data may be published later.
Product specification	This data sheet contains final product specifications.
Limiting values	
Limiting values given are in accordance with the Absolute Maximum Rating System (IEC 134). Stress above one or more of the limiting values may cause permanent damage to the device. These are stress ratings only and operation of the device at these or at any other conditions above those given in the Characteristics sections of the specification is not implied. Exposure to limiting values for extended periods may affect device reliability.	
Application information	
Where application information is given, it is advisory and does not form part of the specification.	

LIFE SUPPORT APPLICATIONS

These products are not designed for use in life support appliances, devices, or systems where malfunction of these products can reasonably be expected to result in personal injury. Philips customers using or selling these products for use in such applications do so at their own risk and agree to fully indemnify Philips for any damages resulting from such improper use or sale.

Philips Semiconductors – a worldwide company

Argentina: see South America

Australia: 34 Waterloo Road, NORTH RYDE, NSW 2113,
Tel. +61 2 9805 4455, Fax. +61 2 9805 4466

Austria: Computerstr. 6, A-1101 WIEN, P.O. Box 213,
Tel. +43 1 60 101, Fax. +43 1 60 101 1210

Belarus: Hotel Minsk Business Center, Bld. 3, r. 1211, Volodarski Str. 6,
220050 MINSK, Tel. +375 172 200 733, Fax. +375 172 200 773

Belgium: see The Netherlands

Brazil: see South America

Bulgaria: Philips Bulgaria Ltd., Energoproject, 15th floor,
51 James Bourchier Blvd., 1407 SOFIA,
Tel. +359 2 689 211, Fax. +359 2 689 102

Canada: PHILIPS SEMICONDUCTORS/COMPONENTS,
Tel. +1 800 234 7381, Fax. +1 708 296 8556

China/Hong Kong: 501 Hong Kong Industrial Technology Centre,
72 Tat Chee Avenue, Kowloon Tong, HONG KONG,
Tel. +852 2319 7888, Fax. +852 2319 7700

Colombia: see South America

Czech Republic: see Austria

Denmark: Prags Boulevard 80, PB 1919, DK-2300 COPENHAGEN S,
Tel. +45 32 88 2636, Fax. +45 31 57 1949

Finland: Sinikalliontie 3, FIN-02630 ESPOO,
Tel. +358 615 800, Fax. +358 615 80920

France: 4 Rue du Port-aux-Vins, BP317, 92156 SURESNES Cedex,
Tel. +33 1 40 99 6161, Fax. +33 1 40 99 6427

Germany: Hammerbrookstraße 69, D-20097 HAMBURG,
Tel. +49 40 23 52 60, Fax. +49 40 23 536 300

Greece: No. 15, 25th March Street, GR 17778 TAVROS,
Tel. +30 1 4894 339/911, Fax. +30 1 4814 240

Hungary: see Austria

India: Philips INDIA Ltd, Shivsagar Estate, A Block, Dr. Annie Besant Rd.
Worli, MUMBAI 400 018, Tel. +91 22 4938 541, Fax. +91 22 4938 722

Indonesia: see Singapore

Ireland: Newstead, Clonskeagh, DUBLIN 14,
Tel. +353 1 7640 000, Fax. +353 1 7640 200

Israel: RAPAC Electronics, 7 Kehilat Saloniki St, TEL AVIV 61180,
Tel. +972 3 645 0444, Fax. +972 3 648 1007

Italy: PHILIPS SEMICONDUCTORS, Piazza IV Novembre 3,
20124 MILANO, Tel. +39 2 6752 2531, Fax. +39 2 6752 2557

Japan: Philips Bldg 13-37, Kohnan 2-chome, Minato-ku, TOKYO 108,
Tel. +81 3 3740 5130, Fax. +81 3 3740 5077

Korea: Philips House, 260-199 Itaewon-dong, Yongsan-ku, SEOUL,
Tel. +82 2 709 1412, Fax. +82 2 709 1415

Malaysia: No. 76 Jalan Universiti, 46200 PETALING JAYA, SELANGOR,
Tel. +60 3 750 5214, Fax. +60 3 757 4880

Mexico: 5900 Gateway East, Suite 200, EL PASO, TEXAS 79905,
Tel. +1 800 234 7381, Fax. +1 708 296 8556

Middle East: see Italy

Netherlands: Postbus 90050, 5600 PB EINDHOVEN, Bldg. VB,
Tel. +31 40 27 83749, Fax. +31 40 27 88399

New Zealand: 2 Wagener Place, C.P.O. Box 1041, AUCKLAND,
Tel. +64 9 849 4160, Fax. +64 9 849 7811

Norway: Box 1, Manglerud 0612, OSLO,
Tel. +47 22 74 8000, Fax. +47 22 74 8341

Philippines: Philips Semiconductors Philippines Inc.,
106 Valero St. Salcedo Village, P.O. Box 2108 MCC, MAKATI,
Metro MANILA, Tel. +63 2 816 6380, Fax. +63 2 817 3474

Poland: Ul. Lukiska 10, PL 04-123 WARSZAWA,
Tel. +48 22 612 2831, Fax. +48 22 612 2327

Portugal: see Spain

Romania: see Italy

Russia: Philips Russia, Ul. Usatcheva 35A, 119048 MOSCOW,
Tel. +7 095 926 5361, Fax. +7 095 564 8323

Singapore: Lorong 1, Toa Payoh, SINGAPORE 1231,
Tel. +65 350 2538, Fax. +65 251 6500

Slovakia: see Austria

Slovenia: see Italy

South Africa: S.A. PHILIPS Pty Ltd., 195-215 Main Road Martindale,
2092 JOHANNESBURG, P.O. Box 7430 Johannesburg 2000,
Tel. +27 11 470 5911, Fax. +27 11 470 5494

South America: Rua do Rocio 220, 5th floor, Suite 51,
04552-903 São Paulo, SÃO PAULO - SP, Brazil,
Tel. +55 11 821 2333, Fax. +55 11 829 1849

Spain: Balmes 22, 08007 BARCELONA,
Tel. +34 3 301 6312, Fax. +34 3 301 4107

Sweden: Kottbygatan 7, Akalla, S-16485 STOCKHOLM,
Tel. +46 8 632 2000, Fax. +46 8 632 2745

Switzerland: Allmendstrasse 140, CH-8027 ZÜRICH,
Tel. +41 1 488 2686, Fax. +41 1 481 7730

Taiwan: PHILIPS TAIWAN Ltd., 23-30F, 66,
Chung Hsiao West Road, Sec. 1, P.O. Box 22978,
TAIPEI 100, Tel. +886 2 382 4443, Fax. +886 2 382 4444

Thailand: PHILIPS ELECTRONICS (THAILAND) Ltd.,
209/2 Sanpavuth-Bangna Road Prakanong, BANGKOK 10260,
Tel. +66 2 745 4090, Fax. +66 2 398 0793

Turkey: Talatpasa Cad. No. 5, 80640 GÜLTEPE/ISTANBUL,
Tel. +90 212 279 2770, Fax. +90 212 282 6707

Ukraine: PHILIPS UKRAINE, 2A Akademika Koroleva str., Office 165,
252148 KIEV, Tel. +380 44 476 0297/1642, Fax. +380 44 476 6991

United Kingdom: Philips Semiconductors Ltd., 276 Bath Road, Hayes,
MIDDLESEX UB3 5BX, Tel. +44 181 730 5000, Fax. +44 181 754 8421

United States: 811 East Arques Avenue, SUNNYVALE, CA 94088-3409,
Tel. +1 800 234 7381, Fax. +1 708 296 8556

Uruguay: see South America

Vietnam: see Singapore

Yugoslavia: PHILIPS, Trg N. Pasica 5/v, 11000 BEOGRAD,
Tel. +381 11 825 344, Fax. +381 11 635 777

For all other countries apply to: Philips Semiconductors, Marketing & Sales Communications, Building BE-p, P.O. Box 218, 5600 MD EINDHOVEN, The Netherlands, Fax. +31 40 27 24825

Internet: <http://www.semiconductors.philips.com/ps/>

© Philips Electronics N.V. 1996

SCA50

All rights are reserved. Reproduction in whole or in part is prohibited without the prior written consent of the copyright owner.

The information presented in this document does not form part of any quotation or contract, is believed to be accurate and reliable and may be changed without notice. No liability will be accepted by the publisher for any consequence of its use. Publication thereof does not convey nor imply any license under patent- or other industrial or intellectual property rights.

Printed in The Netherlands

647021/1200/01/pp12

Date of release: 1996 Jul 17

Document order number: 9397 750 00971

Let's make things better.

**Philips
Semiconductors**



PHILIPS