

DATA SHEET

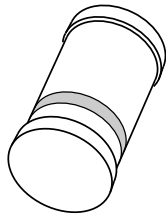

BAS85 Schottky barrier diode

Product specification
Supersedes data of 1996 Mar 20
File under Discrete Semiconductors, SC01

1996 Oct 01

Schottky barrier diode

BAS85

FEATURES

- Low forward voltage
- High breakdown voltage
- Guard ring protected
- Hermetically-sealed small SMD package.

APPLICATIONS

- Ultra high-speed switching
- Voltage clamping
- Protection circuits
- Blocking diodes.

DESCRIPTION

Planar Schottky barrier diode with an integrated protection ring against static discharges.
This surface mounted diode is

encapsulated in a hermetically sealed SOD80C glass SMD package with tin-plated metal discs at each end. It is suitable for "automatic placement" and as such it can withstand immersion soldering.

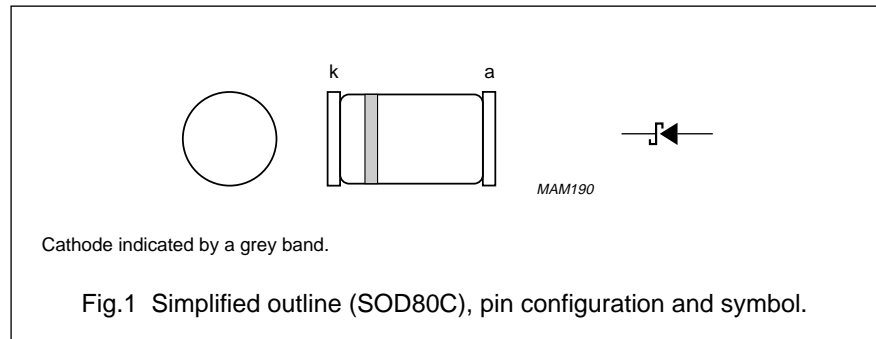

LIMITING VALUES

In accordance with the Absolute Maximum Rating System (IEC 134).

SYMBOL	PARAMETER	CONDITIONS	MIN.	MAX.	UNIT
V_R	continuous reverse voltage		–	30	V
I_F	continuous forward current		–	200	mA
$I_{F(AV)}$	average forward current	$V_{RWM} = 25 \text{ V}$; $a = 1.57$; $\delta = 0.5$; note 1; Fig.2	–	200	mA
I_{FRM}	repetitive peak forward current	$t_p \leq 1 \text{ s}$; $\delta \leq 0.5$	–	300	mA
I_{FSM}	non-repetitive peak forward current	$t_p = 10 \text{ ms}$	–	5	A
T_{stg}	storage temperature		–65	+150	°C
T_j	junction temperature		–	125	°C
T_{amb}	operating ambient temperature		–65	+125	°C

Note

1. Refer to SOD80 standard mounting conditions.

Schottky barrier diode

BAS85

ELECTRICAL CHARACTERISTICS $T_{amb} = 25\text{ }^{\circ}\text{C}$ unless otherwise specified.

SYMBOL	PARAMETER	CONDITIONS	MAX.	UNIT
V_F	forward voltage	see Fig.3 $I_F = 0.1\text{ mA}$ $I_F = 1\text{ mA}$ $I_F = 10\text{ mA}$ $I_F = 30\text{ mA}$ $I_F = 100\text{ mA}$	240 320 400 500 800	mV mV mV mV mV
I_R	reverse current	$V_R = 25\text{ V}$; note 1; see Fig.4	2.3	μA
C_d	diode capacitance	$f = 1\text{ MHz}$; $V_R = 1\text{ V}$; see Fig.5	10	pF

Note

1. Pulsed test: $t_p = 300\text{ }\mu\text{s}$; $\delta = 0.02$.

THERMAL CHARACTERISTICS

SYMBOL	PARAMETER	CONDITIONS	VALUE	UNIT
$R_{th\text{-}j\text{-}a}$	thermal resistance from junction to ambient	note 1	320	K/W

Note

1. Refer to SOD80 standard mounting conditions.

Schottky barrier diode

BAS85

GRAPHICAL DATA

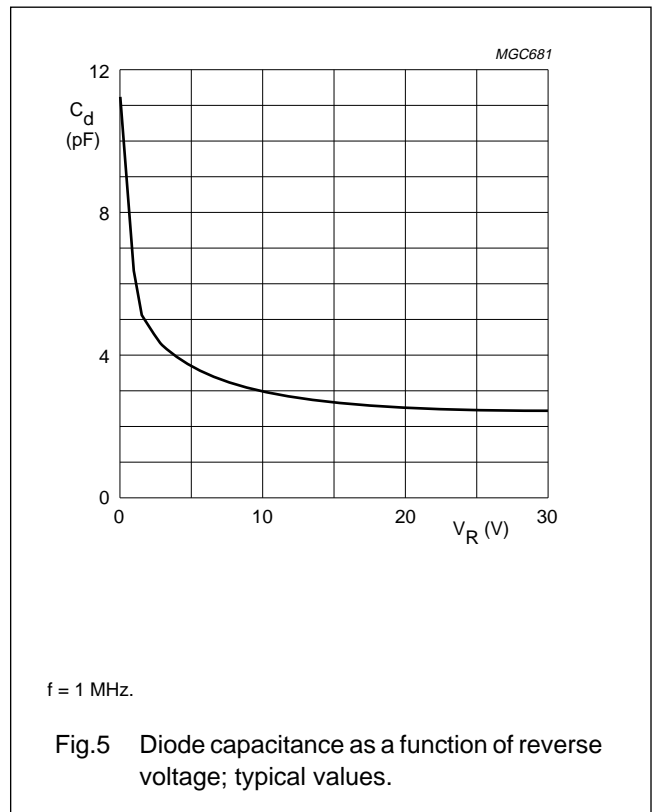
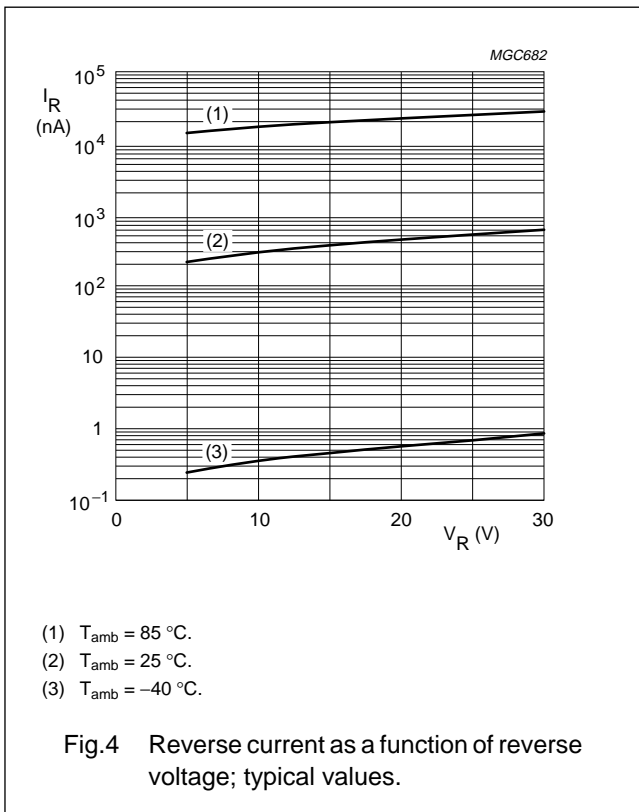
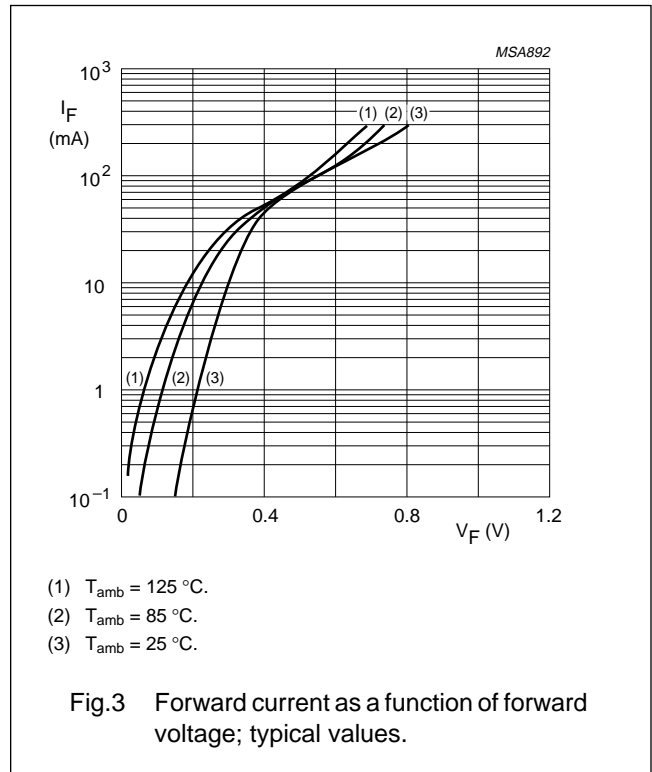
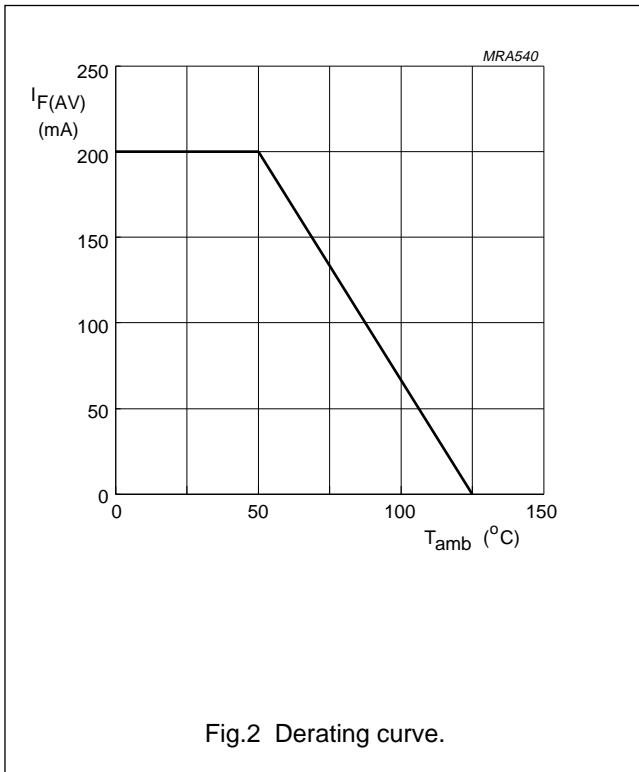

Schottky barrier diode

BAS85

PACKAGE OUTLINE

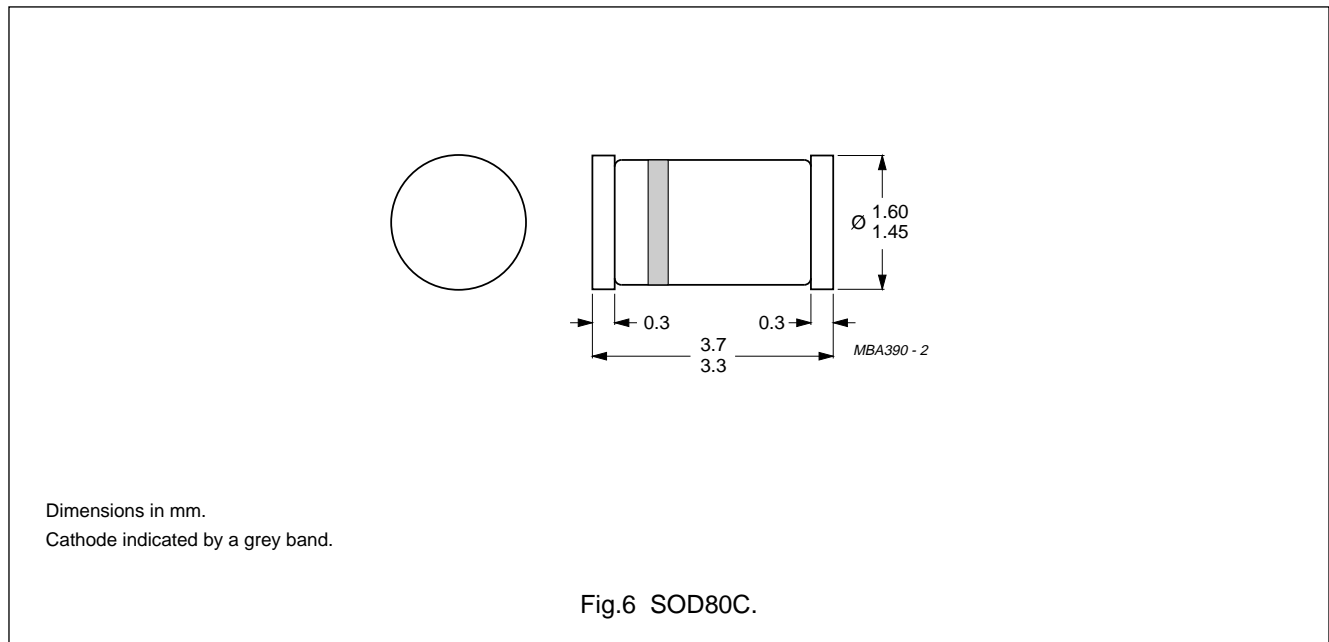

DEFINITIONS

Data sheet status	
Objective specification	This data sheet contains target or goal specifications for product development.
Preliminary specification	This data sheet contains preliminary data; supplementary data may be published later.
Product specification	This data sheet contains final product specifications.
Limiting values	
Limiting values given are in accordance with the Absolute Maximum Rating System (IEC 134). Stress above one or more of the limiting values may cause permanent damage to the device. These are stress ratings only and operation of the device at these or at any other conditions above those given in the Characteristics sections of the specification is not implied. Exposure to limiting values for extended periods may affect device reliability.	
Application information	
Where application information is given, it is advisory and does not form part of the specification.	

LIFE SUPPORT APPLICATIONS

These products are not designed for use in life support appliances, devices, or systems where malfunction of these products can reasonably be expected to result in personal injury. Philips customers using or selling these products for use in such applications do so at their own risk and agree to fully indemnify Philips for any damages resulting from such improper use or sale.