

# DATA SHEET

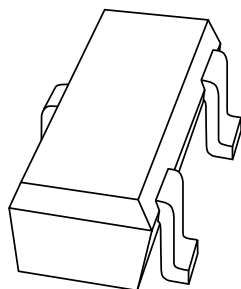

**1PS302**

High-speed double diode

Product specification  
Supersedes data of April 1996  
File under Discrete Semiconductors, SC01

1996 Sep 03

# High-speed double diode

# 1PS302

### FEATURES

- Very small plastic SMD package
- High switching speed: max. 4 ns
- Continuous reverse voltage: max. 80 V
- Repetitive peak reverse voltage: max. 85 V
- Repetitive peak forward current: max. 500 mA.

### APPLICATIONS

- High-speed switching in e.g. surface mounted circuits.

### DESCRIPTION

The 1PS302 consists of two high-speed switching diodes connected in series, fabricated in planar technology, and encapsulated in the very small rectangular plastic SMD SC70 package.

### PINNING

PIN	DESCRIPTION
1	anode
2	cathode
3	common connection

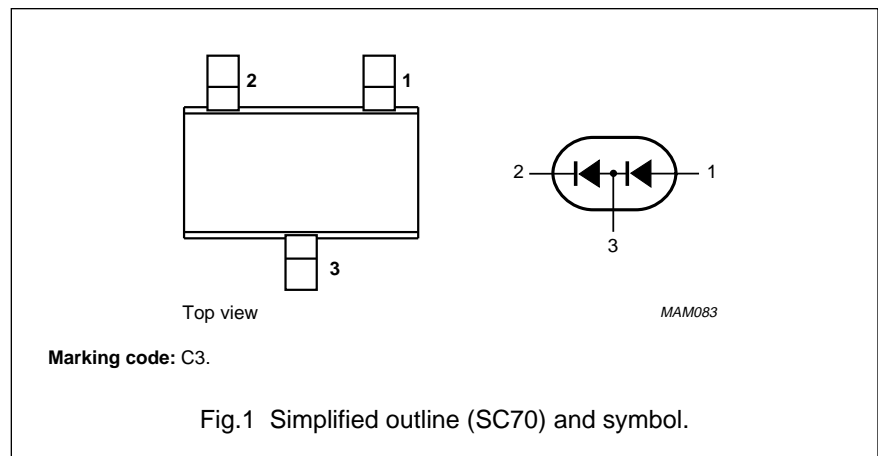

### LIMITING VALUES

In accordance with the Absolute Maximum Rating System (IEC 134).

SYMBOL	PARAMETER	CONDITIONS	MIN.	MAX.	UNIT
<b>Per diode</b>					
$V_{RRM}$	repetitive peak reverse voltage		–	85	V
$V_R$	continuous reverse voltage		–	80	V
$I_F$	continuous forward current	single diode loaded; see Fig.2; note 1	–	200	mA
		double diode loaded; see Fig.2; note 1	–	170	mA
$I_{FRM}$	repetitive peak forward current		–	500	mA
$I_{FSM}$	non-repetitive peak forward current	square wave; $T_j = 25\text{ °C}$ prior to surge			
		$t = 1\ \mu\text{s}$	–	4	A
		$t = 1\ \text{s}$	–	0.5	A
$P_{tot}$	total power dissipation	$T_{amb} = 25\text{ °C}$ ; note 1	–	300	mW
$T_{stg}$	storage temperature		–65	+150	°C
$T_j$	junction temperature		–	150	°C

### Note

1. Device mounted on an FR4 printed-circuit board.

## High-speed double diode

1PS302

**ELECTRICAL CHARACTERISTICS** $T_j = 25\text{ }^\circ\text{C}$ ; unless otherwise specified.

SYMBOL	PARAMETER	CONDITIONS	TYP.	MAX.	UNIT
<b>Per diode</b>					
$V_F$	forward voltage	see Fig.3			
		$I_F = 1\text{ mA}$	610	–	mV
		$I_F = 10\text{ mA}$	740	–	mV
		$I_F = 50\text{ mA}$	–	1.0	V
		$I_F = 100\text{ mA}$	–	1.2	V
$I_R$	reverse current	see Fig.4			
		$V_R = 25\text{ V}$	–	30	nA
		$V_R = 80\text{ V}$	–	0.5	$\mu\text{A}$
		$V_R = 25\text{ V}; T_j = 150\text{ }^\circ\text{C}$	–	30	$\mu\text{A}$
		$V_R = 80\text{ V}; T_j = 150\text{ }^\circ\text{C}$	–	100	$\mu\text{A}$
$C_d$	diode capacitance	$f = 1\text{ MHz}; V_R = 0$ ; see Fig.5	–	1.5	pF
$t_{rr}$	reverse recovery time	when switched from $I_F = 10\text{ mA}$ to $I_R = 10\text{ mA}$ ; $R_L = 100\ \Omega$ ; measured at $I_R = 1\text{ mA}$ ; see Fig.6	–	4	ns
$V_{fr}$	forward recovery voltage	when switched from $I_F = 10\text{ mA}$ ; $t_r = 20\text{ ns}$ ; see Fig.7	–	1.75	V

**THERMAL CHARACTERISTICS**

SYMBOL	PARAMETER	CONDITIONS	VALUE	UNIT
$R_{th\ j-tp}$	thermal resistance from junction to tie-point		200	K/W
$R_{th\ j-a}$	thermal resistance from junction to ambient	note 1	415	K/W

**Note**

- Device mounted on an FR4 printed-circuit board.

# High-speed double diode

1PS302

## GRAPHICAL DATA

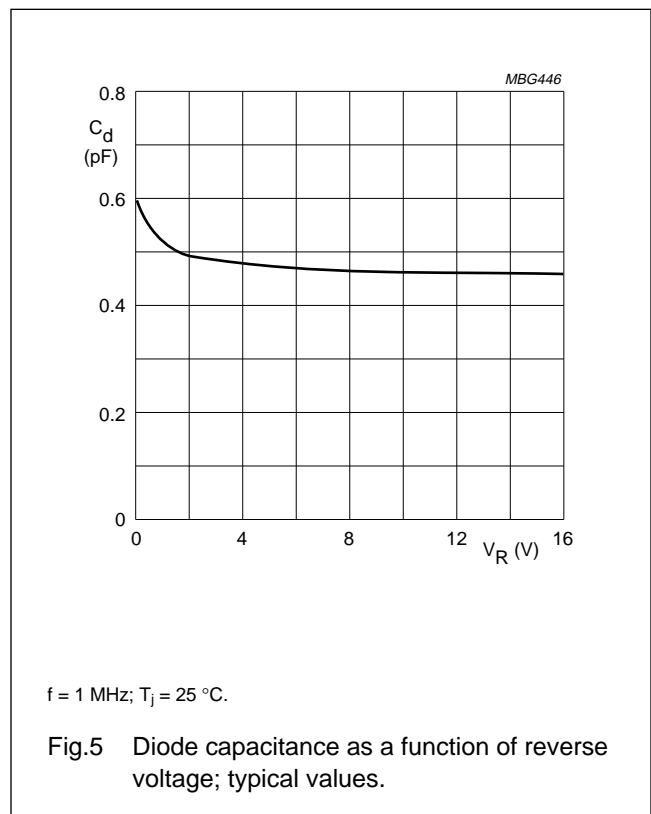
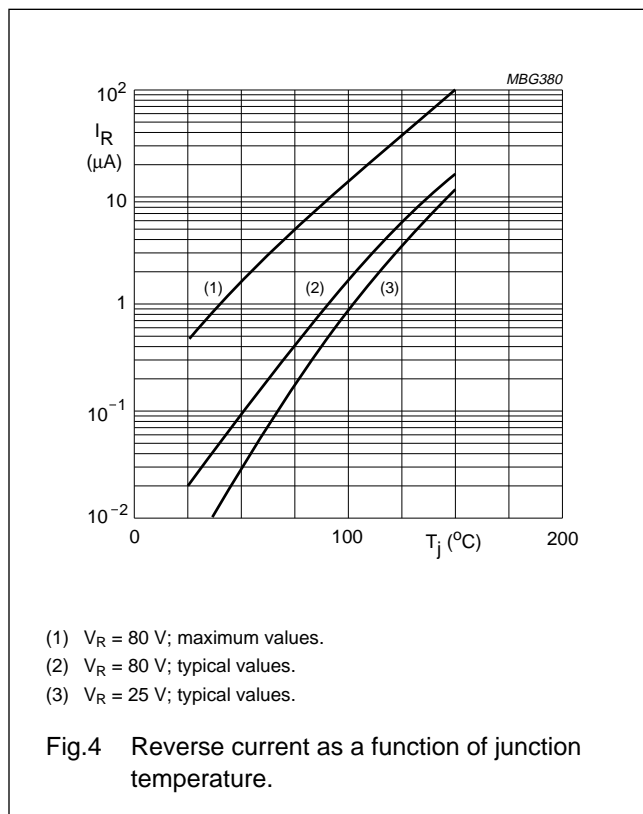
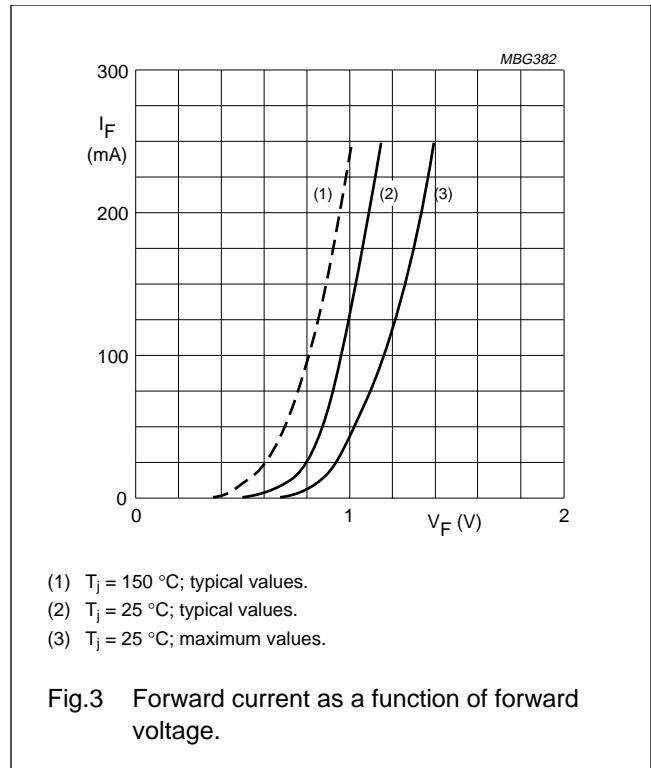
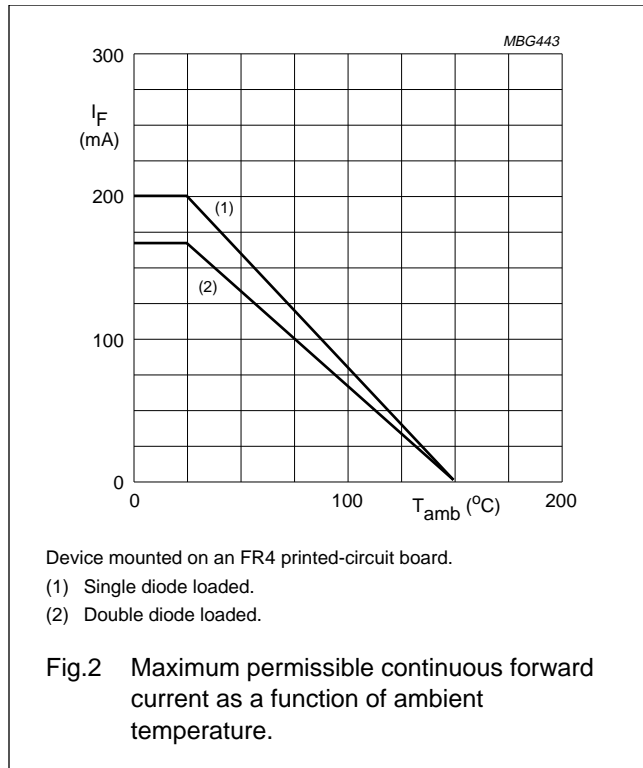

High-speed double diode

1PS302

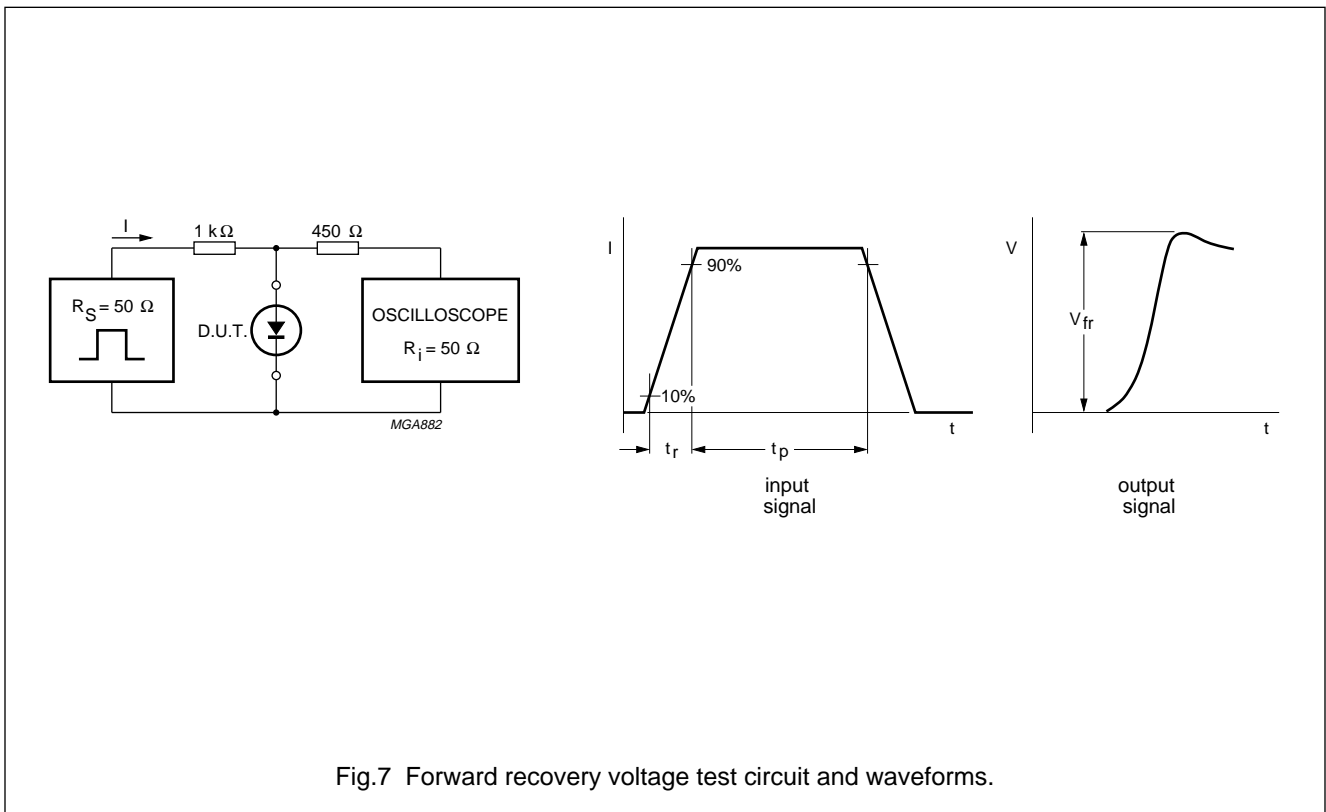
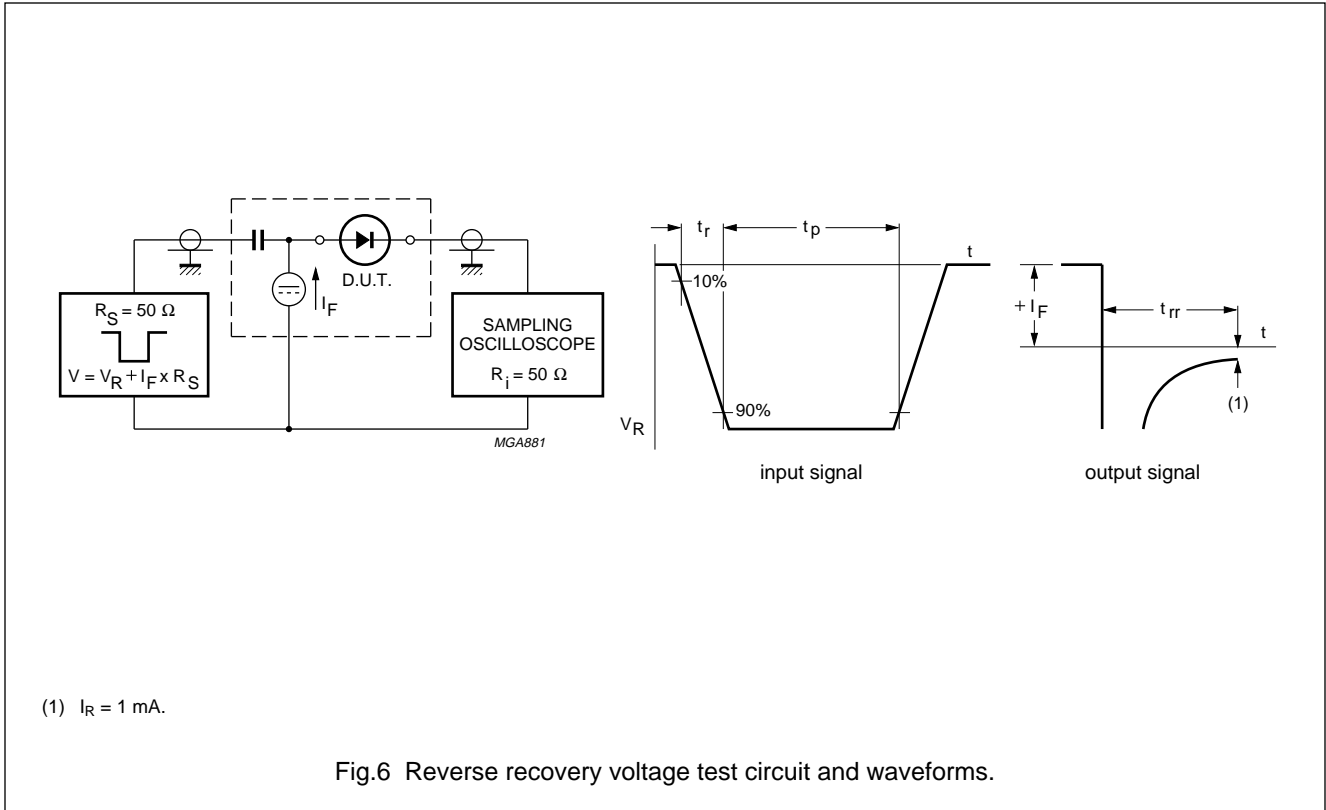

# High-speed double diode

1PS302

## PACKAGE OUTLINE

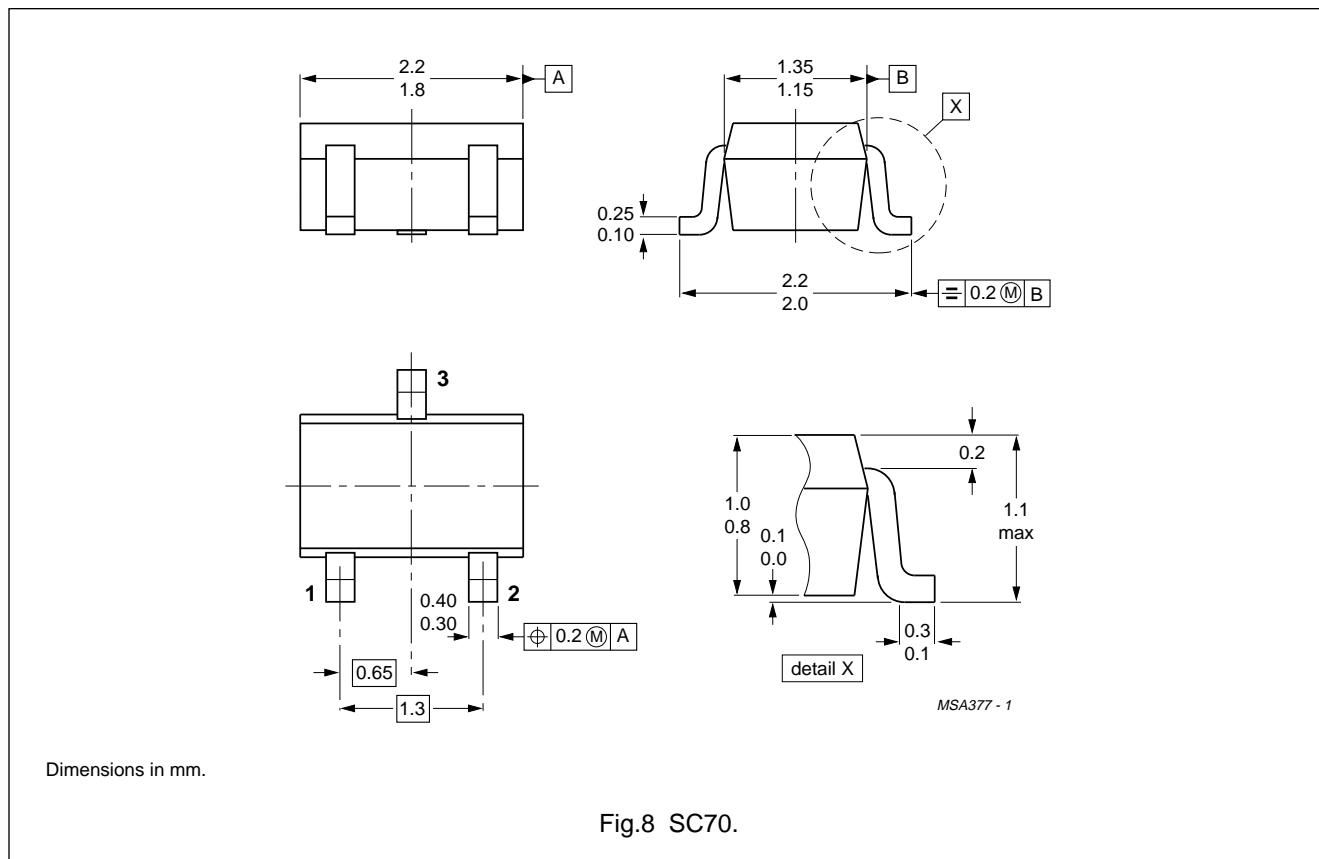

## DEFINITIONS

Data Sheet Status	
Objective specification	This data sheet contains target or goal specifications for product development.
Preliminary specification	This data sheet contains preliminary data; supplementary data may be published later.
Product specification	This data sheet contains final product specifications.
Limiting values	
Limiting values given are in accordance with the Absolute Maximum Rating System (IEC 134). Stress above one or more of the limiting values may cause permanent damage to the device. These are stress ratings only and operation of the device at these or at any other conditions above those given in the Characteristics sections of the specification is not implied. Exposure to limiting values for extended periods may affect device reliability.	
Application information	
Where application information is given, it is advisory and does not form part of the specification.	

## LIFE SUPPORT APPLICATIONS

These products are not designed for use in life support appliances, devices, or systems where malfunction of these products can reasonably be expected to result in personal injury. Philips customers using or selling these products for use in such applications do so at their own risk and agree to fully indemnify Philips for any damages resulting from such improper use or sale.