

# DATA SHEET

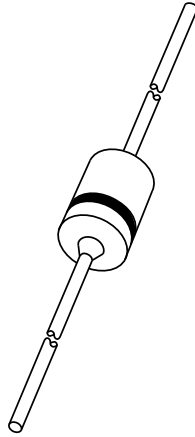

## **BA316; BA317; BA318** High-speed diodes

Product specification  
Supersedes data of April 1996  
File under Discrete Semiconductors, SC01

1996 Sep 11

## High-speed diodes

## BA316; BA317; BA318

## FEATURES

- Hermetically sealed leaded glass SOD27 (DO-35) package
- High switching speed: max. 4 ns
- General application
- Continuous reverse voltage: 10 V, 30 V, 50 V
- Repetitive peak reverse voltage: max. 15 V, 40 V, 60 V
- Repetitive peak forward current: max. 225 mA.

## APPLICATIONS

- High-speed switching.

## DESCRIPTION

The BA316, BA317, BA318 are high-speed switching diodes fabricated in planar technology, and encapsulated in hermetically sealed leaded glass SOD27 (DO-35) packages.

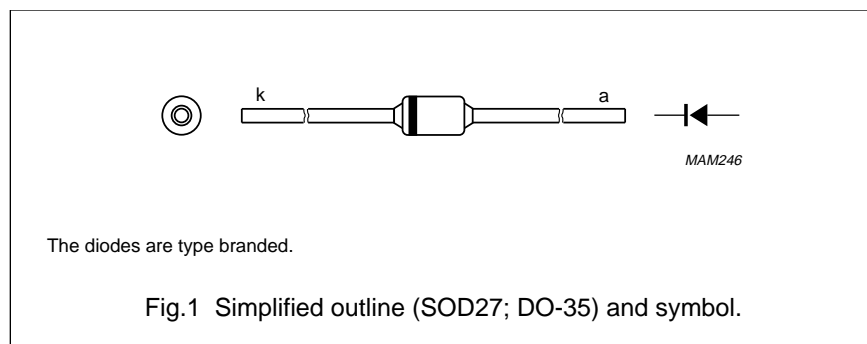

## LIMITING VALUES

In accordance with the Absolute Maximum Rating System (IEC 134).

SYMBOL	PARAMETER	CONDITIONS	MIN.	MAX.	UNIT
$V_{RRM}$	repetitive peak reverse voltage		–		
	BA316		–	15	V
	BA317		–	40	V
	BA318		–	60	V
$V_R$	continuous reverse voltage		–		
	BA316		–	10	V
	BA317		–	30	V
	BA318		–	50	V
$I_F$	continuous forward current	see Fig.2; note 1	–	100	mA
$I_{FRM}$	repetitive peak forward current		–	225	mA
$I_{FSM}$	non-repetitive peak forward current	square wave; $T_j = 25\text{ °C}$ prior to surge; see Fig.4			
		$t = 1\ \mu\text{s}$	–	4	A
		$t = 1\ \text{ms}$	–	1	A
		$t = 1\ \text{s}$	–	0.5	A
$P_{tot}$	total power dissipation	$T_{amb} = 25\text{ °C}$ ; note 1	–	350	mW
$T_{stg}$	storage temperature		–65	+200	°C
$T_j$	junction temperature		–	200	°C

## Note

1. Device mounted on an FR4 printed circuit-board; lead length 10 mm.

## High-speed diodes

## BA316; BA317; BA318

**ELECTRICAL CHARACTERISTICS** $T_j = 25\text{ °C}$ ; unless otherwise specified.

SYMBOL	PARAMETER	CONDITIONS	MIN.	MAX.	UNIT
$V_F$	forward voltage	see Fig.3 $I_F = 1\text{ mA}$	–	700	mV
		$I_F = 10\text{ mA}$	–	850	mV
		$I_F = 100\text{ mA}$	–	1100	mV
$I_R$	reverse current BA316	see Fig.5 $V_R = 10\text{ V}$	–	200	nA
		$V_R = 10\text{ V}; T_j = 150\text{ °C}$	–	100	$\mu\text{A}$
	BA317	$V_R = 10\text{ V}$	–	50	nA
		$V_R = 30\text{ V}$	–	200	nA
		$V_R = 30\text{ V}; T_j = 150\text{ °C}$	–	100	$\mu\text{A}$
	BA318	$V_R = 30\text{ V}$	–	50	nA
		$V_R = 50\text{ V}$	–	200	nA
		$V_R = 50\text{ V}; T_j = 150\text{ °C}$	–	100	$\mu\text{A}$
$C_d$	diode capacitance	$f = 1\text{ MHz}; V_R = 0$ ; see Fig.6	–	2	pF
$t_{rr}$	reverse recovery time	when switched from $I_F = 10\text{ mA}$ to $I_R = 60\text{ mA}$ ; $R_L = 100\ \Omega$ ; measured at $I_R = 1\text{ mA}$ ; see Fig.7	–	4	ns
$V_{fr}$	forward recovery voltage	when switched from $I_F = 50\text{ mA}$ ; $t_r = 20\text{ ns}$ ; see Fig.8	–	2.5	V

**THERMAL CHARACTERISTICS**

SYMBOL	PARAMETER	CONDITIONS	VALUE	UNIT
$R_{th\ j-tp}$	thermal resistance from junction to tie-point	lead length 10 mm	240	K/W
$R_{th\ j-a}$	thermal resistance from junction to ambient	lead length 10 mm; note 1	500	K/W

**Note**

1. Device mounted on a printed circuit-board without metallization pad.

# High-speed diodes

# BA316; BA317; BA318

## GRAPHICAL DATA

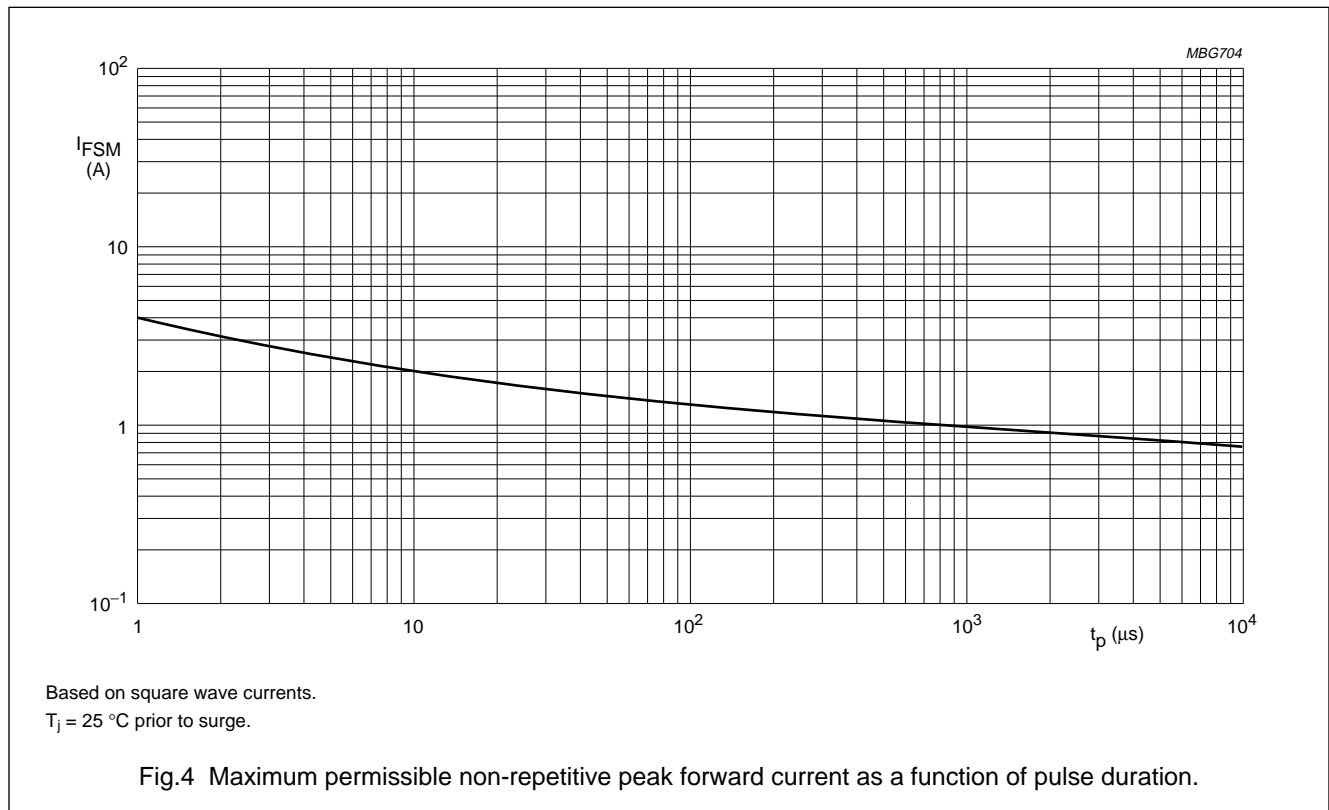
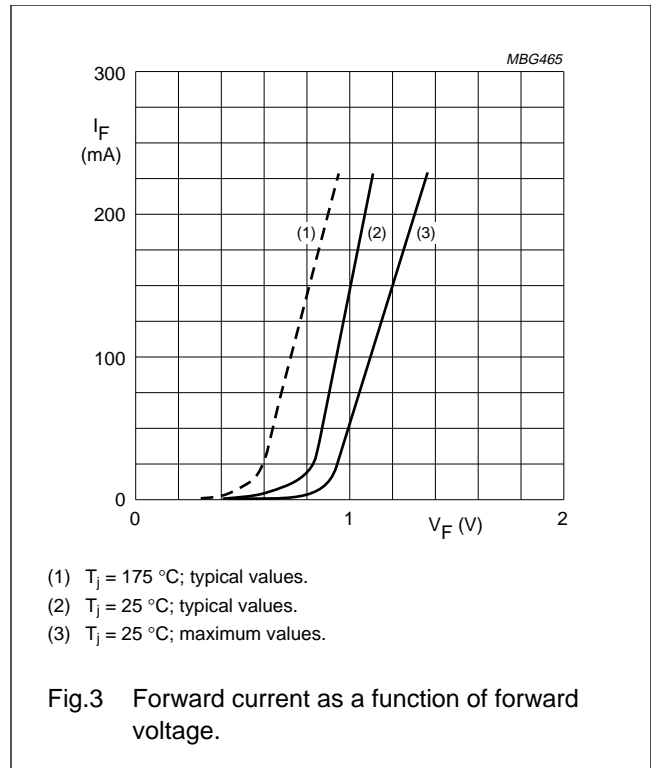
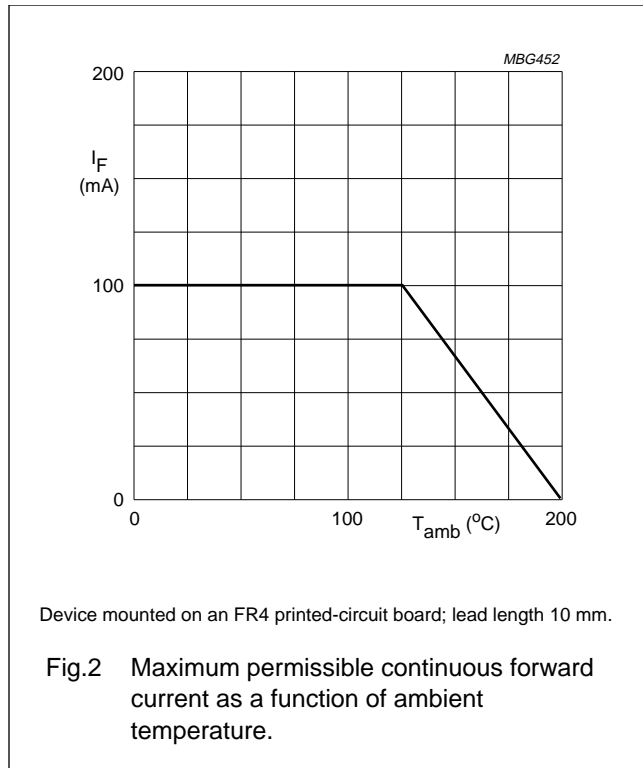

High-speed diodes

BA316; BA317; BA318

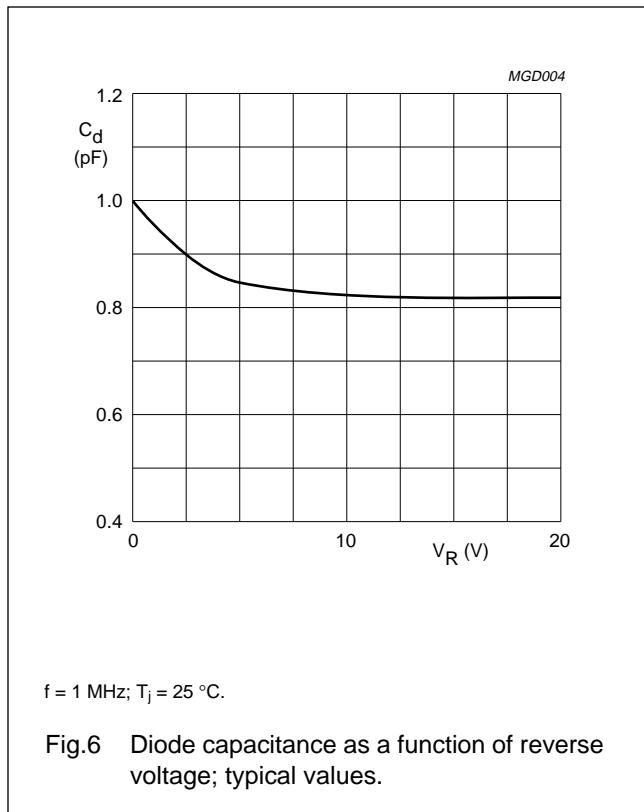
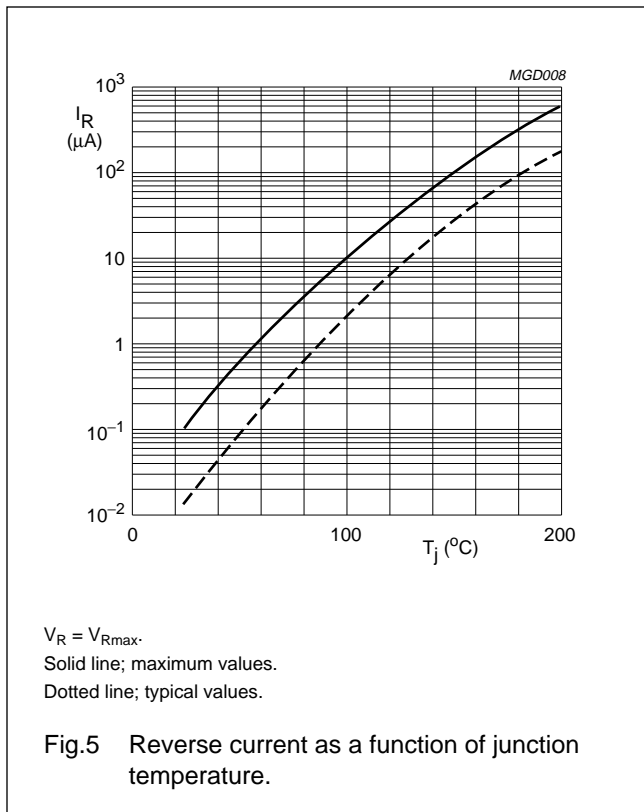

High-speed diodes

BA316; BA317; BA318

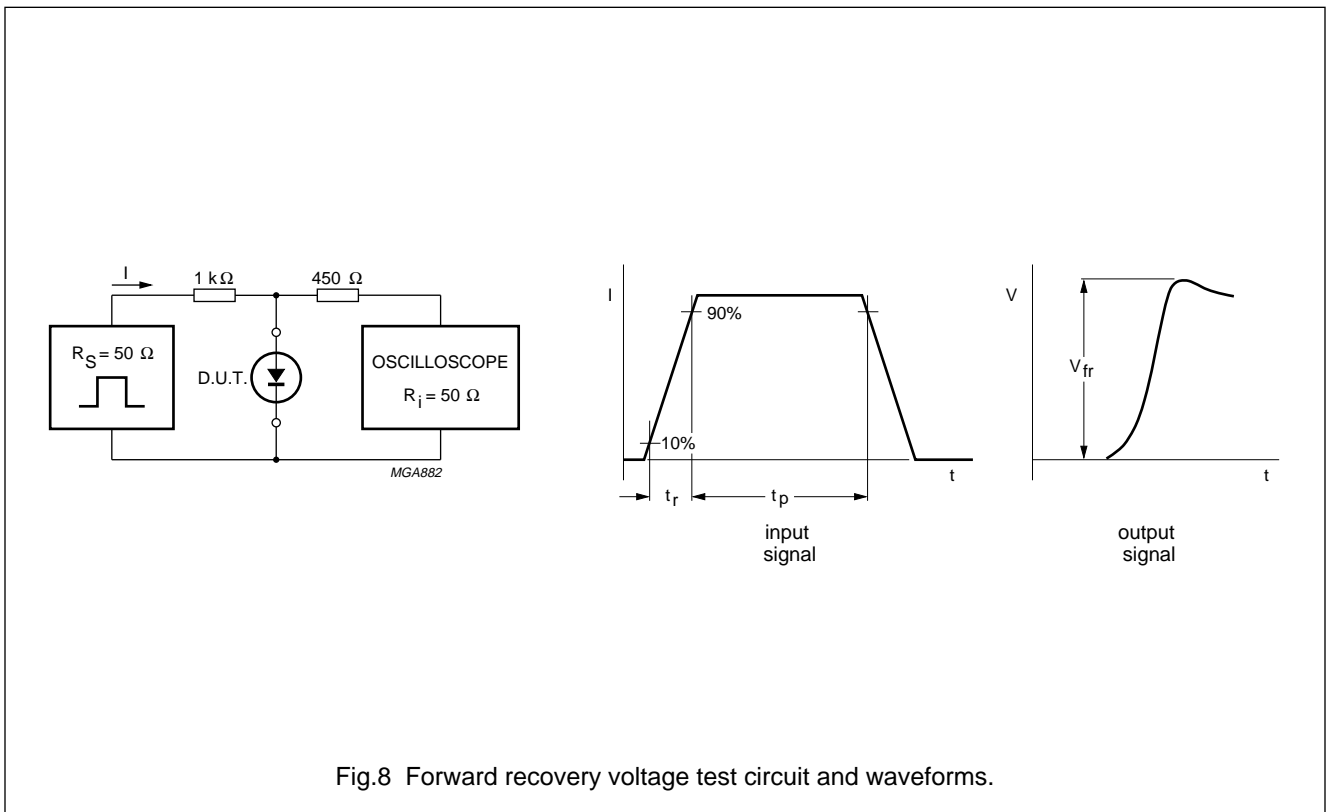
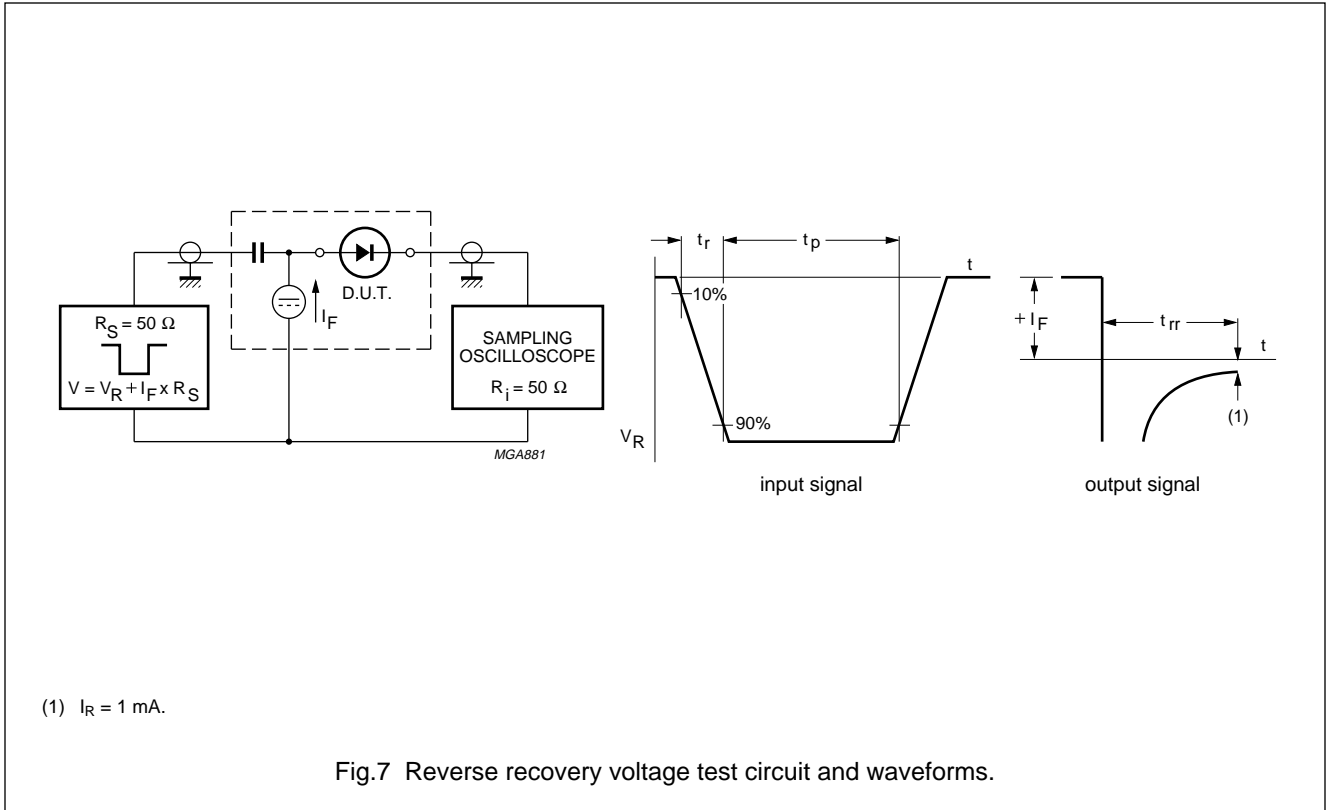

High-speed diodes

BA316; BA317; BA318

PACKAGE OUTLINE

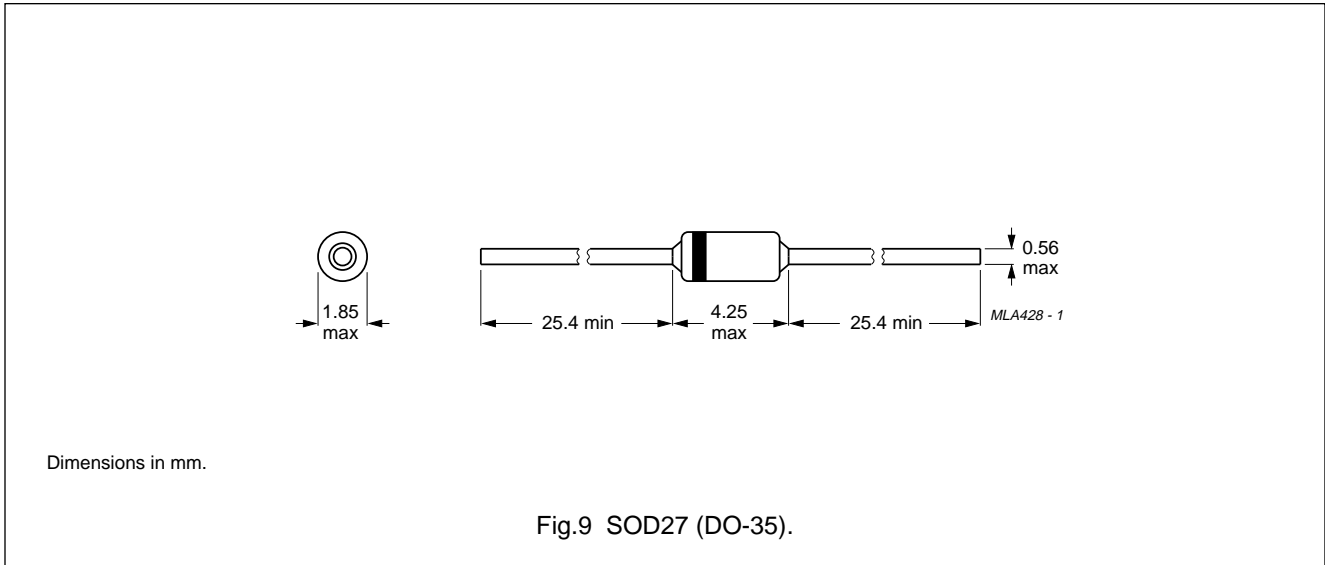

DEFINITIONS

<b>Data Sheet Status</b>	
Objective specification	This data sheet contains target or goal specifications for product development.
Preliminary specification	This data sheet contains preliminary data; supplementary data may be published later.
Product specification	This data sheet contains final product specifications.
<b>Limiting values</b>	
Limiting values given are in accordance with the Absolute Maximum Rating System (IEC 134). Stress above one or more of the limiting values may cause permanent damage to the device. These are stress ratings only and operation of the device at these or at any other conditions above those given in the Characteristics sections of the specification is not implied. Exposure to limiting values for extended periods may affect device reliability.	
<b>Application information</b>	
Where application information is given, it is advisory and does not form part of the specification.	

LIFE SUPPORT APPLICATIONS

These products are not designed for use in life support appliances, devices, or systems where malfunction of these products can reasonably be expected to result in personal injury. Philips customers using or selling these products for use in such applications do so at their own risk and agree to fully indemnify Philips for any damages resulting from such improper use or sale.